

# Powerley Thermostat

Installation & Operation Guide

©2017 Powerley, LLC. or its affiliates. All rights reserved. Powerley and the Powerley logo are trademarks of Powerley, LLC. and its affiliates.

# Welcome!

After a quick installation, your new Powerley Thermostat will allow you to monitor and control your HVAC system from anywhere in the world.

The average homeowner spends up to 50% of their energy costs on HVAC use. With the Powerley Thermostat, you'll have a great opportunity to reduce those costs by intelligently managing temperature setpoints.

To take full advantage of features such as setpoint scheduling, use the companion app on your iOS or Android device to connect your Powerley Thermostat to your Energy Bridge.

It is recommended to hire a professional HVAC installer. However, if you do opt to install on your own, we'll guide you along the entire process.

Let's get started!

## Contents

Getting to Know your Thermostat.....	2
Installation.....	4
Thermostat Setup.....	10
Setup Troubleshooting.....	11
Compatibility.....	12

## Quick Start



### Step 1

Take photo of existing thermostat wiring



### Step 2

Install Powerley Thermostat



### Step 3

Use app to include the Powerley Thermostat



### Step 4

Set up your thermostat schedule in the app

## Getting to know your thermostat

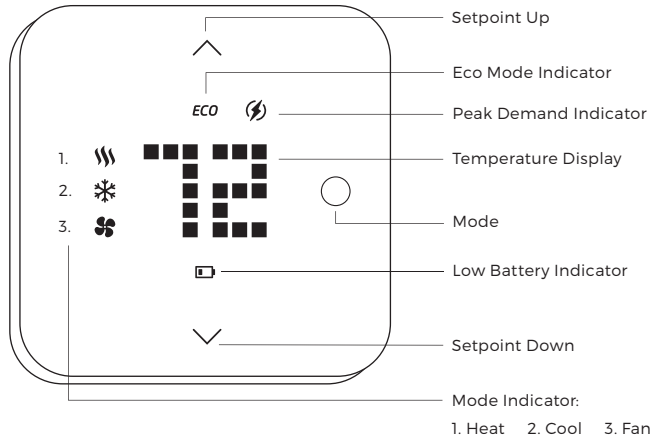

### Limitation of Damages

In addition to the above warranty disclaimers, in no event will Powerley be liable for any consequential, incidental, exemplary, or special damages, including any damages for lost data or lost profits, arising from or relating to this limited warranty or the product, and Powerley total cumulative liability arising from or related to this limited warranty or the product will not exceed the amount actually paid for the product by the original purchaser.

### Disclaimer of Warranties

Except as stated above in this limited warranty, and to the maximum extent permitted by applicable law, Powerley disclaims all express, implied, and statutory warranties and conditions with respect to the product, including the implied warranties of merchantability, fitness for a particular purpose. To the maximum extent permitted by applicable law, Powerley also limits the duration of any implied warranties or conditions to the duration of this limited warranty.



## Limitation of Liability

Powerley disclaims all liability of any kind of Powerley's suppliers. The Powerley Thermostat Installation & Operation Guide contains an online link for updated versions of the operation guide and software products/and or application(s) are available for added functionality ("Services") both of which provide you different information ("Product Information") and compatibility information regarding use of the Powerley Thermostat and your HVAC system including the type of products that may be connected to your thermostat which may change from time to time. The services may be used to control compatible HVAC system via the product. Without limiting the generality of the disclaimers above, all product information is provided for your convenience, "as is", and "as available". Powerley does not represent, warrant, or guarantee that product information will be available, accurate, or reliable or that product information or use of the services or product will decrease the energy consumption of your home. You are solely responsible for all energy bills incurred by your home. You use all product information, the services, and the product at your own discretion and risk. You will be solely responsible for (and Powerley disclaims) any and all loss, liability, or damages, including to your HVAC system, plumbing, home, product, product peripherals, computer, mobile device, and all other items and pets in your home, resulting from your use of the product information, services, or product. Product information provided by the services is not intended as a substitute for direct means of obtaining the information. For example, a temperature reading in the product information provided by the services is not intended as a substitute for reading the temperature as directly displayed by the product.



## Waking Up

To wake up your thermostat, press Mode once. The display will light up with the ambient temperature and the Heat or Cool mode indicator if either is active.

## Selecting Modes

To select a mode, press Mode repeatedly to cycle between Heat , Cool , and Off mode.

## Adjusting Setpoints

To adjust the setpoint, first make sure your thermostat is in Heat  or Cool  mode as indicated by the mode indicator. Tap the setpoint up or down arrows to adjust to your target setpoint. The temperature display and mode indicator will blink during the setpoint adjustment.

Once you've settled on a mode and setpoint, you can either press Mode (while the display is blinking) to confirm your selection or simply wait for a few seconds to automatically confirm your selection and return to displaying ambient temperature.

- **Setpoint Up/Down:** Allow you to adjust your thermostat setpoint.
- **Eco Mode Indicator:** This LED will appear when you are in energy efficiency mode.
- **Peak Demand Indicator:** This LED will appear when you are in a Peak Demand event.
- **Mode:** Press Mode to wake the thermostat up and cycle between modes.
- **Low Battery Indicator:** If your thermostat is operated on batteries, this LED will appear when batteries need to be replaced.
- **Mode Indicators:** The thermostat's current mode will display here.

## Installation

### 1. Important! Shut off power to HVAC system

Put your existing thermostat in Off mode, then shut off power to your HVAC system either at the circuit breaker or the system switch.

**CAUTION:** Shut off main power to protect yourself and your equipment!

### 2. Take a picture of wiring for existing thermostat before removing it

Remove the front of your existing thermostat and take a picture of the wire configuration. This will be your guide when installing your new thermostat. If any wires are the same color, be sure to mark them with tape to identify them.

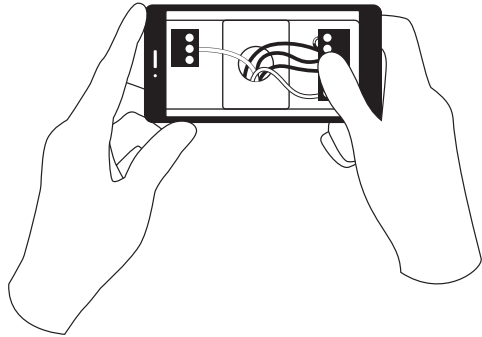

### FCC Notice

This device complies with Part 15 of the FCC Rules. Operation is subject to the following two conditions:

1. This device may not cause harmful interference, and
2. This device must accept any interference received, including interference that may cause undesired operation.

### Note

This equipment has been tested and found to comply with the limits for a Class B digital device, pursuant to Part 15 of the FCC Rules. These limits are designed to provide reasonable protection against harmful interference in a residential installation. This equipment generates, uses and can radiate radio frequency energy and, if not installed and used in accordance with the instructions, may cause harmful interference to radio communications. However, there is no guarantee that interference will not occur in a particular installation. If this equipment does cause harmful interference to radio or television reception, which can be determined by turning the equipment off and on, the user is encouraged to try to correct the interference by one or more of the following measures:

- Reorient or relocate the receiving antenna.
- Increase the separation between the equipment and receiver.
- Connect the equipment into an outlet on a circuit different from that to which the receiver is connected.
- Consult the dealer or an experienced radio/TV technician for help.

### Information to User

The users manual or instruction manual for an intentional or unintentional radiator shall caution the user that changes or modifications not expressly approved by the party responsible for compliance could void the user's authority to operate the equipment.

## Installation Location

This thermostat is for indoor use only. It should be mounted on an inner wall about 5ft (1.5m) above the floor at a position where it is readily affected by changes of the general room temperature with freely circulating air. Avoid mounting above or near hot surfaces or equipment (e.g. TV, heater, refrigerator). Avoid mounting where it will be exposed to direct sunshine, drafts, or in a laundry room or other enclosed space. Do not expose this unit to dripping or splashing liquids.

## Device Information

Purpose of Control: Operating Control  
Construction of Control: Independently Mounted Control  
Pollution Degree: 2  
Impulse Voltage: 330 V



## 3. Check Compatibility

Before continuing to Step 4, check your HVAC system compatibility on page 12. Once you're sure your system is compatible, remove the existing thermostat from the wall.

## 4. Mount Wallplate

To separate the wallplate from the thermostat front, grasp the sides of the front while holding the opening in wallplate and pull apart.

Mount the wallplate using the screws and anchors provided. If necessary, drill a 1/4-in hole for drywall or 5/32-in hole for plaster.

**NOTE:** Make sure the arrows on the wallplate are facing up.

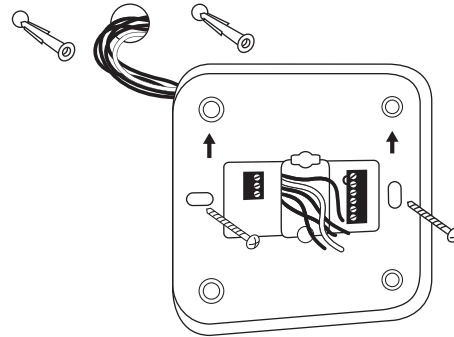

## 5. Connect Wires (Conventional System)

A conventional one-stage system usually has 4-5 wires, while a conventional multi-stage system has 6-7 wires. Use the picture you took in Step 2 to determine which color wire goes to which terminal. Refer to the wiring guide on the next page to confirm your wiring configuration.

Loosen the screw by turning it counterclockwise and insert the wire on inside edge of the terminal block. Tighten the screw by turning clockwise to secure the wire in its terminal. Repeat for remaining wires.

If you have a heat pump system, refer to its user manual for correct wire configuration. See pg. 8 for the heat pump jumper configuration guide. You should configure the heat pump jumper prior to providing power to your Thermostat.

**NOTE:** Do not remove the metal jumper between terminal blocks RH and RC unless you have both RH and RC wires connected.

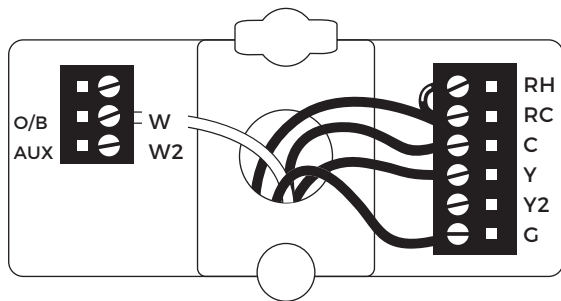

### Caution!

- Do not modify the unit in any way: Risk of fire, electrical shock, or burns if modified.
- Do not dispose of electrical appliances and unsorted municipal waste, use separate collection facilities. Contact your local government for information regarding the collection systems available.
- There are no user serviceable parts in this unit.
- Risk of explosion if battery is replaced by an incorrect type. Dispose of used batteries according to the instructions.
- Installation by a trained HVAC Technician is recommended.
- Read all enclosed instructions thoroughly before installing your new thermostat.
- Give special attention to all warnings, notes and installation steps to minimize risk of damaging the thermostat or the HVAC system.
- Label all wires before disconnecting. Taking a picture is also recommended in case the old thermostat must be re-installed.
- Switch off power to your HVAC system either at the circuit breaker or the system switch before installing.

### Battery Safety

- Use new batteries, per the specification sheet.
- Never mix old and new batteries.
- Prevent leaking by removing dead batteries when notified.
- Recycle and save the environment.



## Wireless Information

This device has an open-air line-of-sight transmission distance of 132 feet (40m) which complies with Z-Wave standards. Performance can vary depending on the amount of objects in between Z-Wave devices such as walls and furniture.

This product can be operated in any Z-Wave network with other Z-Wave certified devices from other manufacturers. All non-battery operated nodes within the network will act as repeaters regardless of vendor to increase reliability of the network.

### Radio Frequency Limitations:

1. Each wall or object (i.e.: refrigerator, bookshelf, large TV, etc) can reduce the maximum range of 65 feet (20m) by up to 20 to 30%.
2. Plasterboard and wooden walls block less radio signal than concrete, brick or tile walls which will have more of an effect on signal strength.
3. Wall mounted Z-Wave devices will also suffer range loss when housed in metal junction boxes and could reduce the range by up to 20-30%.

## Maintenance

- Do not expose your unit to dust, strong sunlight, humidity, high temperatures or mechanical shock.
- Do not use old and new batteries together as old batteries tend to leak.
- Do not use corrosive or abrasive cleansers on your unit.
- Use a water wet cloth to clean the soft plastic surface.
- Keep the unit dust free by wiping it with a soft, dry cloth.
- Do not disassemble the unit.

## Wiring Guide

Symbols	Terminals
O	Cool Changeover (Heat Pump)
B	Heat Changeover (Heat Pump)
W1 or W	1 <sup>st</sup> Stage Heater
W2	2 <sup>nd</sup> Stage Heater
RH	24Vac Power for Heating
RC	24Vac Power for Cooling
C *	24Vac Common *
Y1 or Y	1 <sup>st</sup> Stage Compressor
Y2	2 <sup>nd</sup> Stage Compressor
G	1 <sup>st</sup> Stage Fan

**\*NOTE:** If you do not have a C-wire, the thermostat may be powered by installing (4) AA batteries.



 **CAUTION: DO NOT** install batteries with C-wire connected.

## 6. Heat Pump Configuration

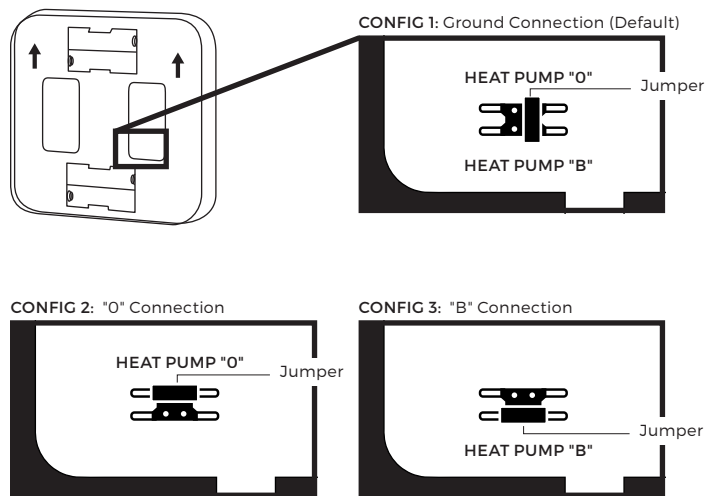
If you have a heat pump, you should configure the heat pump jumper prior to providing power to your Thermostat. The jumper is located on the back of the Thermostat face, in the lower left of the right-side opening. Pull the jumper straight out to remove, then configure according to your heat pump type. See configuration options below.



## Technical Specifications

- RF Frequency 915MHz (US)
- RF Operating Distance:
  - Up to 132ft (40m) outdoor line of sight, in unobstructed environment
- Capacitive touch with white LEDs display
- Status icons: 6
-    control buttons and LEDs
- Powered By: Dry battery AA x 4pcs or 24 VAC +/-20% 50/60Hz
- Relay Contact Voltage: 24 VAC 50/60 Hz
- Current: 1A Max. (inductive)
- Temp Unit: °F / °C
- Temp Measurable Range: -4°F to 185°F, -20°C to 85°C
- Humidity Range: 0 to 100% relative humidity
- Temp Setting Range: 45°F to 90°F, 7°C to 32°C
- Temp Dead Band: 3°F, 4°F, 5°F or 6°F
- Operating Temp: 32°F to 131°F, 0°C to 55°C
- Storage Temp: -4°F to 176°F, -20°C to 80°C
- Dimension (L x H x T): 120mm x 120mm x 30mm
- Weight: 255g (Batteries excluded)

## Compatibility

### Compatible HVAC Systems

- 24Vac single & 2-stage conventional heating systems (gas, oil or electric)
- Heat pump systems with up to 2 stages of heating (electric or gas)
- Boiler systems
- One or two stage cooling systems

### Incompatible HVAC Systems

- Radiant floor and wall heating systems
- Zoned forced air and zoned hot water (2 or 3 wire)
- Hybrid systems/Dual-fuel systems
- Geothermal systems
- Multi-zoned systems
- 110V or higher line voltage systems (e.g. electric baseboard heaters)
- Millivolt systems (12-24Vac or DC source)

**NOTE:** Thick black, red, or white wires connected with wire nuts running to existing thermostat typically mean high voltage system.

### 7. Attach thermostat to wallplate

Align the guides from the thermostat to the wallplate and gently press into place. The magnetic closure will keep the two pieces secured.

 **CAUTION: DO NOT** install batteries with C-wire connected.

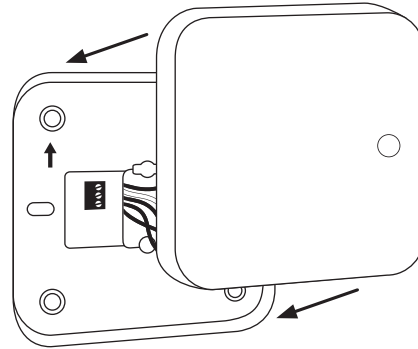

### 8. Switch on main power to your HVAC system

Once you have your new thermostat in place, power your HVAC system back on at the circuit breaker or system switch.

Press Mode on your thermostat to wake it up. It will display the current ambient temperature once it has power.

## Thermostat Setup

### 1. Launch Setup

You're now ready to connect your Powerley Thermostat to your Energy Bridge! Launch the app and begin thermostat setup, which will guide you through the setup process.

### 2. Z-Wave Inclusion Process

First, be sure your Energy Bridge has power and the green light is illuminated. Follow the in-app instructions along with the steps below to include your Thermostat.

To put your thermostat into inclusion mode, press and hold Mode for 5 seconds.

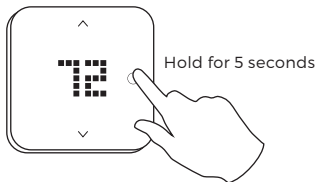

- **CONNECT** will scroll across the thermostat display once in inclusion mode.
- **SUCCESS** will scroll across the thermostat display once included.
- **FAIL** will scroll across the thermostat display if inclusion is unsuccessful, or if process takes longer than 1 minute. See the next page for troubleshooting.

To learn more about which Z-Wave command classes this thermostat supports, visit: [www.powerley.com/thermostat/command-classes](http://www.powerley.com/thermostat/command-classes)

## Setup Troubleshooting

If you are experiencing issues with connectivity and/or controlling the thermostat from the app, it may be necessary to exclude and re-include the thermostat to your Z-Wave network. If these issues persist, factory reset the thermostat and retry the inclusion process.

### Z-Wave Exclusion Process

To exclude your Thermostat, press and hold Mode for 5 seconds to initiate Z-Wave exclusion process.

- **DELETE** will scroll across the thermostat display once in exclusion mode.
  - To cancel the exclusion process, press Mode.
  - To complete exclusion press either of the up/down arrows.
- **SUCCESS** will scroll across the thermostat display once excluded.

**NOTE:** Excluding the thermostat will restore it to the default state for Z-Wave and temperature set points.

### Factory Reset

Please use Factory Reset only when the network primary controller is missing or otherwise inoperable. To reset to factory defaults, turn the thermostat off by pressing Mode repeatedly until **OFF** scrolls across the display, then press and hold the down and up Setpoint arrows at the same time for 5 sec. If successful, **RESET** will scroll across the display and the device will be restored to its default settings.

**NOTE:** If a reset to factory default settings is performed, all settings including Z-Wave configuration parameter values and temperature setpoints will return to default values: **Heat:** 68 **Cool:** 78 **Measure:** Fahrenheit **Swing:** +/- 1 **Multi-stage temp differential:** 3 **System Type:** 2-stage conventional heating & cooling