

FLOOD SENSOR

Engineering Specification

Flood Sensor is capable of both detecting leaks and floods and when the level of water gets too low in pool or tank, Flood Sensor can work with your Z-Wave network to prevent emergencies such as burst water boiler to leaking air conditioners. With Z-Wave, the scope to save money is endless.

The features list:

- 1) Z-Wave Plus certified for wide compatibility (500 serials product).
- 2) Security 0 and security 2 framework implemented with AES-128 encryption.
- 3) Contains an extension water detecting probe.
- 4) Temperature measurement.
- 5) Vibration sensor.
- 6) The battery life is up to 1 year.
- 7) Low battery alert
- 8) Firmware OTA upgrade supported

I . GENERAL INFORMATION ABOUT FLOOD SENSOR

1. Product layout

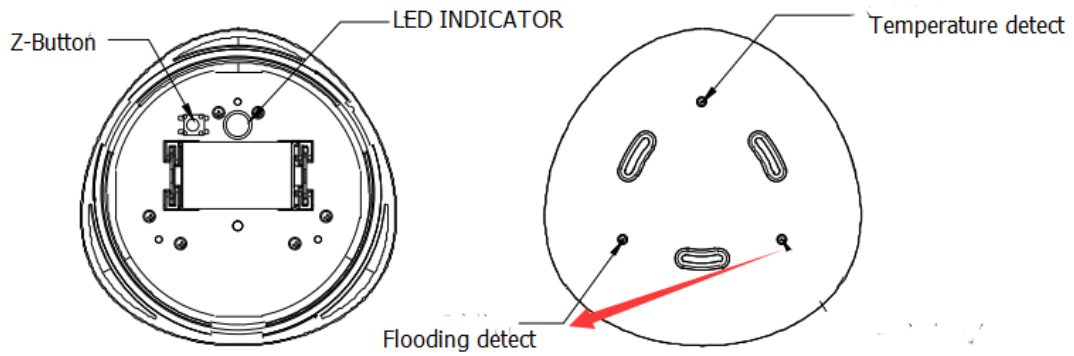

2. Specifications

Power supply:	ER14250 3.6V Battery
Storage environment:	-10℃ -50℃ 0%-90%
Operational temperature:	0-40℃
Radio protocol:	Z-Wave plus
Radio frequency:	868.42MHz (EU) 908.42MHz (US) 921.42MHz(ANZ)
Range:	More than 100m outdoors About 30m indoors (depending on building materials)
Dimensions:	Main body: 68 mm(Φ)*22mm(H) Extension probe: 50 mm(Φ)*5mm(H) Wire: 1000mm(L)
Working current:	About 40mA
Standby current:	About 15uA

II . ACTIVATION

1. Turns the cover counter-clockwise and open it.

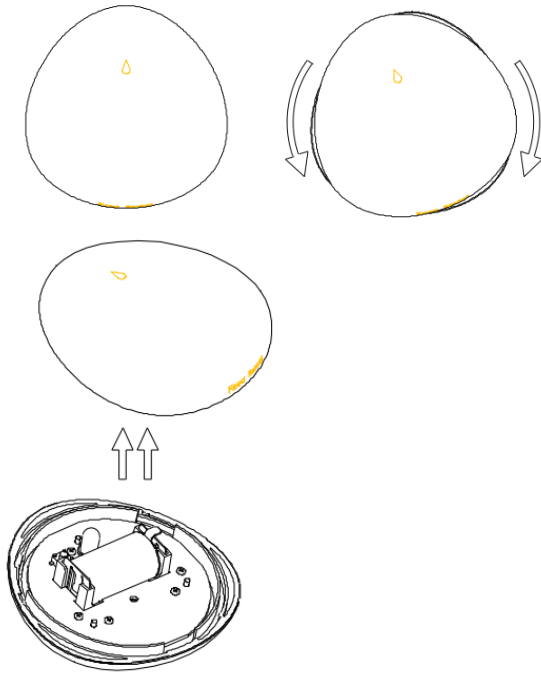

2. Remove the battery blocker.

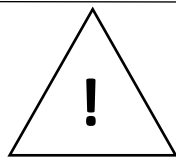
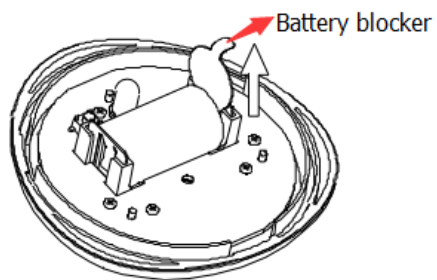

NOTE:

When powered, the device will indicate Z-Wave status with LED:

1. **Blink slowly:** the device is not added to any Z-Wave network.
 2. **Solid:** the device is already added to the Z-Wave network.
-

3. Add the device (see “Adding/removing the device” on page 5).

4. Close the cover and turn it clockwise.

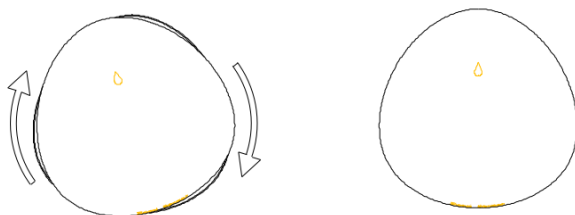

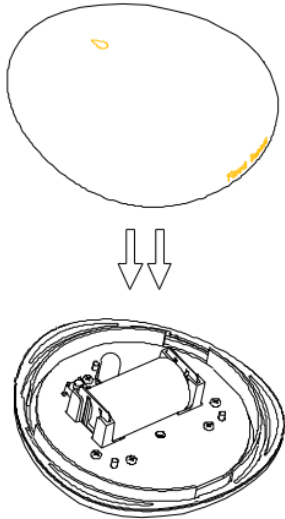

5. Place the sensor on a surface prone to flooding, or use the extension probe (see “Installation” on page 4) .

II . INSTALLATION

Flood Sensor should not be mounted directly on or near metal framing or other large metallic objects since metal objects may weaken the radio signal strength.

After “activation” process, the sensor can work without any installation. Furthermore, you can use the extension probe to fix sensor body.

To install with extension probe, follow the steps:

1) Screw the baseplate of extension probe into the wall and then magnet the sensor body.

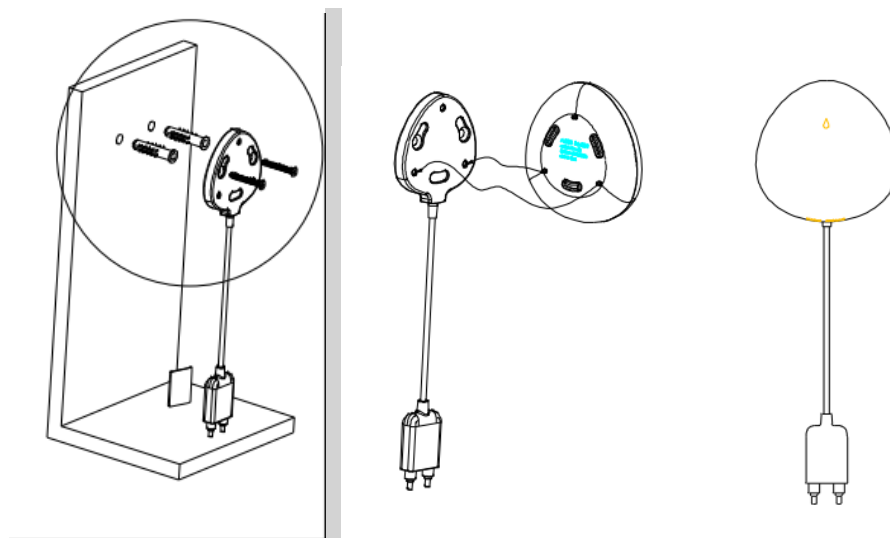

2) Paste the extension probe into any position may flooding.

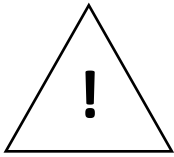
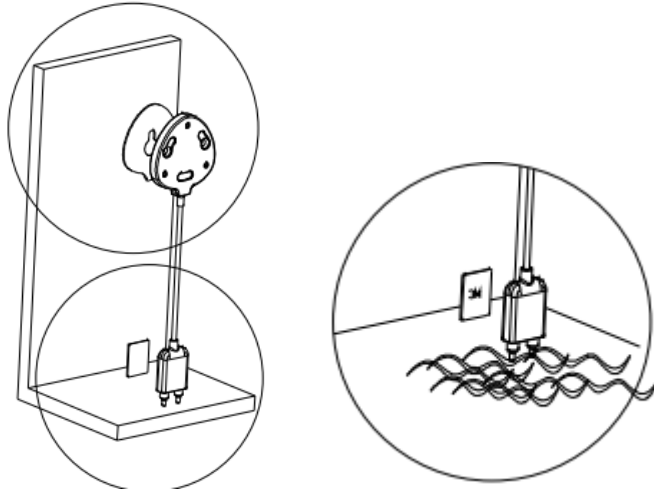

NOTE:

Wipe clean the surface where the flood sensor will be mounted.
Any dust and particles can reduce the adhesion of double-sided mounting tape.

III. ADDING/REMOVING THE DEVICE

Included as a secure device (S0 or S2)

- 1) Open the cover.
- 2) Place the device within the direct range of your Z-Wave controller.
- 3) Set the main controller in security add mode (see the controller's manual).
- 4) Click the Z-button once or triple click the Z-button quickly, the LED indicator should blink fast in blue.

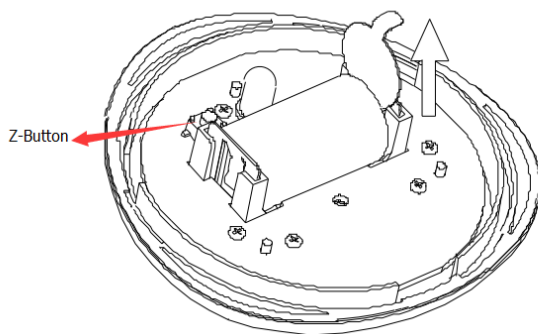

- 1) Wait for the adding process to end.
- 2) Successful adding will be confirmed by the Z-Wave controller's message.

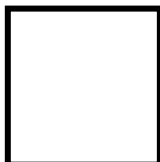

NOTE

If you want your flood sensor to be a security device that use secure/encrypted message to communicate in a Z-Wave network, then a

security enabled Z-Wave controller is needed.

Removing

- 1) Open the cover.
- 2) Place the device within the direct range of your Z-Wave controller.
- 3) Set the main controller remove mode (see the controller’s manual).
- 4) Triple click the Z-button quickly, the LED indicator should blink fast in orange.

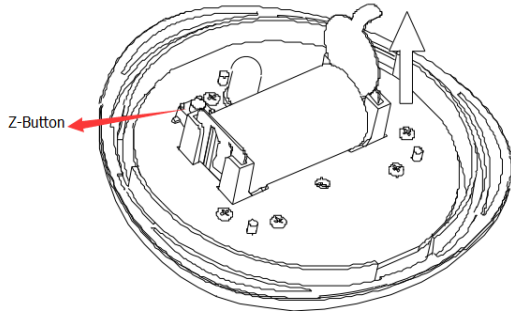

- 5) Wait for the removing process to end.
- 6) Successful Removing will be confirmed by the Z-Wave controller’s message.

IV.Functions of each trigger

Function of Action Button:

FLOOD SENSOR is not in the Z-Wave network:

Trigger	Description
Short press 1 time or short press 3 time(within 1 second)	Entering Learn function, led will blink blue fast. The blue light go on for 3 seconds indicate including success and enter wake-up state, then send Wake up notification CC. When received the "Wake up no more information CC", the product will be out of wake-up state and sleep.

FLOOD SENSOR is in the Z-Wave network:

Trigger	Description
Short press one time (within 1 second)	Wake up product, blue light go on for 1 second.
Short press 3 time (within 1 second)	Entering Learn function, led will blink yellow fast. If successful removing from network, the led will blink yellow slow three times.
Press and hold for 1-3 seconds	Led keep on cyan when holding the Z-Button, turn off when Z-Button is released.
Press and hold for 3-10 seconds	LED keep on green. FLOOD SENSOR will send “wake up notification command” to the nodes which is assigned by “Wake Up Command”. When received the "Wake up no more information CC", exit the wake up state and sleep.
Press and hold for 10-20 seconds	LED will blink orange fast
Press and hold more than 20 seconds	LED keep on orange, FLOOD SENSOR will send “Device_Reset_Locally” to the main controller and exclude from the Z-Wave network when the Z-Button is released, this procedure will reset the Sensor to factory

	default.
--	----------

V. RESETTING

Reset procedure clears the flood sensor's memory, including Z-Wave network controller information and advanced configuration.

To reset a Flood Sensor:

Press and hold the Z-button for more than 20 seconds and then release.

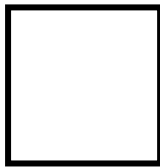

NOTE

Use this procedure only in the event that the network primary controller is missing or otherwise inoperable.

VI. ASSOCIATION and NOTIFICATION

1. Association

Association allows flood sensor to control other Z-Wave device such as Siren, Smart Switch, etc. Flood Sensor supports two association groupings.

Group 1 reports the flooding detection, shock detection temperature and the battery level.

Group 2 is assigned to send BASIC SET command.

Grouping Identifier	Max Nodes	Send Commands
Group 1 General: Lifeline	0x05	<p>1. Notification Report. Sensor will send Notification Report to the associated nodes.</p> <p>2. Battery Report. Flood Sensor will send Battery Report when the battery level is low and the battery report's value is 0xFF.</p> <p>3. Device Reset Locally Notification. Sensor will send Device Reset Locally Notification when reset</p> <p>4. Sensor multilevel report When associated to Group 1, you can adjust the temperature reporting cycle according to the configuration settings.</p>
Group 2 Control:Key01	0x05	<p>1. Basic Set. Flood Sensor will send Basic Set to associated nodes when Water leak detected.</p>

2. Notification

Supported Notification Type	Supported Event
Heat Alarm (0x04)	Overheat detected, Unknown Location(0x02)

	Under heat detected, Unknown Location(0x06)
Water Alarm (0x05)	Water leak detected, Unknown Location(0x02)
Home Security (0x07)	Tampering, Product covering removed (0x03)

- a. When the Overheat detected, send Heat Alarm (04) and Overheat detected, Unknown Location (0x02);
- b. When Under heat detected, send Heat Alarm (04) and under heat detected, Unknown Location (0x06);
- c. When Water leak detected, send Water Alarm (05) and Water leak detected, Unknown Location (0x02);
- d. When Tampering detected, send Home Security (07) Tampering, Product covering removed (0x03);

3. Sensor Multilevel

Sensor Type	Function and Sensor Value
0x01	Temperature Scale = 0: Celsius, Scale = 1: Units are degrees Fahrenheit

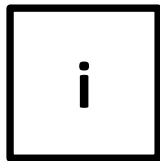

TIP:

1. The max number of associated nodes of all these 2 groups is 5.
2. Association allows for direct transmission of control command between devices and takes place without the participation of the main controller.

VII. WAKE UP

1. Wake up command

1.1. When the product has been online, long press the Z-Wave button for more than 3 seconds to report the product has been awakened.

1.2. Wake up interval set command can be used to configure the product to automatically wake up time. When the value ranges from 0 to 59, the product not wake up automatically. At this time, the product wakes up only through the PIR, buttons, and vibrations. When the value is from 60 to 119, the product wakes up for 60 seconds. When configured value is 120 ~ 179 seconds, the wake up interval of product is 120 seconds, and so on.

1.3 Wake up Interval Capabilities Report CC

Minimum Wake up Interval Seconds = 0 seconds

Maximum Wake up Interval Seconds = 2678400 seconds, that is 31 days

Default Wake up Interval Seconds = 0 seconds

Wake up Interval Step Seconds = 60 seconds



NOTE:

60 seconds is the step of wake up interval time, which means flood Sensor will

send wake up notification command by a timeline that is multiple Of 60 seconds.

Setting examples:

0~59 = 0 second, the device will not wake up by itself.

60~119 = 60 seconds, the device will wake up every 60 seconds.

VIII. Battery command

1. When sending Battery get command to the product, the product will report the current battery power when it wakes up.

2. The battery report value 0xff will be reported to the associated node of group 1 when the product is at a low voltage (the threshold value can be configured in Configuration, the default value is less than 20% of the power).

IX. Security features of Flood Sensor in Z-Wave network

The following is a list of supported command classes:

1.The node info frame supports:

COMMAND_CLASS_ZWAVEPLUS_INFO	V2
COMMAND_CLASS_SECURITY	V1
COMMAND_CLASS_SECURITY_2	V1
COMMAND_CLASS_TRANSPORT_SERVICE	V2

2.Security Command Supported Report Frame:

COMMAND_CLASS_VERSION	V2
COMMAND_CLASS_MANUFACTURER_SPECIFIC	V2
COMMAND_CLASS_NOTIFICATION	V5
COMMAND_CLASS_ASSOCIATION_GRP_INFO	V1
COMMAND_CLASS_ASSOCIATION	V2
COMMAND_CLASS_BATTERY	V1
COMMAND_CLASS_WAKE_UP	V2
COMMAND_CLASS_POWERLEVEL	V1
COMMAND_CLASS_SENSOR_MULTILEVEL	V5
COMMAND_CLASS_CONFIGURATION	V1
COMMAND_CLASS_SUPERVISION	V1
COMMAND_CLASS_FIRMWARE_UPDATE_MD	V3
COMMAND_CLASS_DEVICE_RESET_LOCALLY	V1

X. ADVANCED CONFIGURATION

Flood Sensor offers a wide variety of advanced configuration settings. Below parameters can be accessed from main controllers configuration interface.

Parameter No.14 Enable/Disable BASIC SET command

Flood sensor can send BASIC SET command to nodes associated with group 2.

0 – Disable.

1 – Enable.

Default setting: **0**

Parameter size: **1 [byte]**

Parameter No.15 Value of the BASIC SET

Flood sensor can reverse its value of BASIC SET when flooding is triggered.

0 –Send BASIC SET VALUE = 255 to nodes associated with group 2 when flooding alarm is triggered.

Send BASIC SET VALUE = 0 to nodes associated with group 2 when flooding alarm is canceled.

1 –Send BASIC SET VALUE = 0 to nodes associated with group 2 when flooding alarm is triggered.

Send BASIC SET VALUE = 255 to nodes associated with group 2 when flooding alarm is canceled.

Default setting: **0**

Parameter size: **1[byte]**

Parameter No.17 Set flooding alarm interval (Minute)

0 –Disable flooding alarm.

Others –Enable, The sensor will send report periodically.

Default setting: **5**

Parameter size: **1[byte]**

Parameter No.18 Enable/Disable shock alarm

0 –Disable.

1 –Enable.

Default setting: **0**

Parameter size: **1[byte]**

Parameter No.19 Temperature report time (minute)

The temperature changes at least 1 degree Celsius before reported.

Default setting: **10**

Parameter size: **1[byte]**

Parameter No.20 Set the high temperature alarm trigger value

The precision of the temperature value is 1.

Available settings(US): **-670 - 2570 (-67 – 257°F)**
Available settings(Other): **-550 - 1250 (-55 – 125°C)**
Default setting (US): **1040 (104°F)**
Default setting (Other): **400(40°C)**
Parameter size: **2[byte]**

Parameter No.22 Set the low temperature alarm trigger value

The precision of the temperature value is 1.

Available settings(US): **-670 - 2570 (-67 – 257°F)**
Available settings(Other): **-550 - 1250 (-55 – 125°C)**
Default setting (US): **320 (32°F)**
Default setting (Other): **0 (0°C)**
Parameter size: **2[byte]**

Parameter No.24 Enable/Disable blinking LED when alarm being triggered

0 –Disable.

1 –Enable.

Default setting: **1**

Parameter size: **1[byte]**

Parameter No.32 Level of low battery

This parameter defines a battery level as the “low battery”.

Available settings: **10-50 (10% - 50%)**
Default setting: **20 (20%)**
Parameter size: **1[byte]**

XI.FCC NOTICE

This device complies with part 15 of the FCC Rules. Operation is subject to the following two conditions:

- (1) This device may not cause harmful interference, and
- (2) This device must accept any interference received, including interference that may cause undesired operation.