



Security Tech Germany

SHMK10000

ABUS Z-Wave Magnetic contact



Important information and FAQs about this product and other products can be found on the website

www.abus.com

Version 1.0

*Original operating instructions in English.
Keep for future use!*



Summary

1. Introduction.....	3
1.1. Declaration of Conformity	3
1.2. Disclaimer of Liability	3
2. Important Safety Informations	4
2.1. Intended Use	4
2.2. Unboxing.....	4
2.3. Installation location / operating environment	4
2.4. Children	4
2.5. Information on handling batteries	4
2.6. Important information on battery disposal	5
2.7. Cleaning.....	5
2.8. Information on device disposal	5
3. Product introduction	6
3.1. Scope of delivery	6
3.2. Device features.....	6
3.3. Operating principle	6
3.3. Performance features	7
3.4. Use in systems of different manufacturers	7
4. Overview of functions	7
4.1. Inclusion / Add Device	7
4.2. Mounting & Installation	8
4.3. Exclusion / Remove Device	9
4.4. Reset (Factory-Reset)	10
5. Advanced Z-Wave Parameter	10
5.1. Association Group Information	10
5.2. Unterstützte Command Classes.....	11
6. Technical Specifications	11

1. Introduction

Dear customer,

We are pleased that you have chosen our product and thank you for your trust! You made a good choice.

This Magnetic contact (hereinafter referred to as the "device") has been developed and manufactured with the utmost care. Please read these operating instructions completely and observe all operating and safety instructions, as this ensures the best possible handling of the device. This document is an installation and maintenance manual.

All contained company names and product designations are trademarks of the respective owners. All rights reserved.

If you have any questions, please contact your specialist installer or specialist trade partner!

1.1. Declaration of Conformity

ABUS Security-Center hereby declares that the enclosed product comply with the requirements of the following directives

RED Directive (2014/53/EU), EMC Directive (2014/30/EU), Low Voltage Directive (2014/35/EU) and RoHS Directive (2011/65/EU). The full EU Declaration of Conformity text can be found at:

www.abus.com/product/SHMK10000

It can also be obtained at the following address:

**ABUS Security-Center GmbH & Co. KG,
Linker Kreuthweg 5, 86444 Affing, GERMANY**

1.2. Disclaimer of Liability

These operating instructions have been prepared with the greatest care. Should you nevertheless notice omissions or inaccuracies, please inform us in writing at the above address.

Your rights are limited to the repair or replacement of this product as delivered. ABUS Security Center assumes no liability for any special, incidental or consequential damages, including but not limited to loss of revenue, loss of profit, restrictions in the use of the software, loss or recovery of data, costs for replacement equipment, downtime, property damage and claims of third parties, as a result of and in connection with the use of the software. a. warranty, contractual, legal or claims for damages notwithstanding other limited or implied warranty provisions or in the event that the limited warranty does not apply, the scope of liability of ABUS Security Center is limited to the purchase price of the product.

The contents of this manual are subject to change without notice.

© ABUS Security-Center GmbH & Co. KG, 09/2018

2. Important Safety Informations

2.1. Intended Use

Only use the device for the purpose for which it was built and designed. Any other use is considered unintended.

All guarantee claims are invalid in the event of damage caused by non-compliance with this safety information. We cannot be held liable for resulting damage.

2.2. Unboxing

Handle the device with extreme care when unpacking it.

Packaging and packaging aids can be reused and, as far as possible, should be sent for recycling.

If the original packaging has been damaged, inspect the device first. If the device shows signs of damage, return it in the original packaging and inform the delivery service.

2.3. Installation location / operating environment

Do not place any heavy objects on the device. The device is only designed for operation in spaces with appropriate temperatures or humidity (e.g. bathrooms), or excessive accumulation of dust. Please refer to the individual devices' technical data for more detailed information. Ensure that: adequate ventilation is always guaranteed; no direct sources of heat can affect the device; interior devices are not exposed to direct sunlight or strong artificial light; the device is not in the immediate vicinity of magnetic fields (e.g. loudspeakers); no naked flames (e.g. lit candles) are placed on or next to the device; sprayed or dripping water is prevented from coming into contact with interior devices and caustic fluids are avoided; the device is not operated in the vicinity of water, in particular, the device should never be submerged (do not place objects containing fluids, e.g. vases or drinks, on or near the device); no foreign bodies penetrate the device; the device is not exposed to wide temperature variations, as otherwise there may be condensation from humidity causing electrical short circuits; the device is not exposed to excessive shock or vibration.

2.4. Children

Keep electrical devices out of reach of children. Never allow children to use electrical devices unsupervised. Children may not always properly identify possible hazards. Small parts may be fatal if swallowed. Keep packaging film away from children. There is a risk of suffocation. This device is not intended for children. If used incorrectly, parts under spring tension may fly out and cause injury to children (e.g. to eyes).

2.5. Information on handling batteries

- Make sure that batteries are kept away from small children. Children may put batteries in their mouths and swallow them. This can cause serious harm to their health. If this happens, consult a doctor immediately.
- Do not charge normal batteries, heat them up or throw them into naked flames (they may explode).

- The battery must not be directly exposed to heat or sunlight, and must not be stored in a place with a very high temperature.
- The battery must not come into contact with water.
- The battery must not be dismantled, pierced or otherwise damaged.
- The battery contacts must not be short-circuited.
- Change low batteries in good time.
- Always change all the batteries at the same time and use batteries of the same type.
- Leaky or damaged batteries can cause chemical burns on contact with the skin. In this case, wear protective gloves. Clean the battery compartment with a dry cloth.

2.6. Important information on battery disposal



Batteries with this label do not contain harmful substances such as cadmium, lead and mercury. However, used batteries must not be disposed of along with household waste in accordance with the battery directive. To protect natural resources and promote the recycling of materials, separate the batteries from other waste and deposit them at a local recycling center. An additional label with the chemical symbols for Hg, Cd or Pb means that the batteries contain quantities of mercury, cadmium or lead which exceed the restrictions set by the EU Directive 2006/66/EG. If batteries are not disposed of properly, these substances can cause harm to human health or the environment

2.7. Cleaning

- Dusty devices must be cleaned. You can clean dust from the air vents using a vacuum cleaner or compressed air. If necessary, you can remove the dust with a brush.
- You can clean the surface using a cloth slightly dampened in soapy water. Only use suitable microfiber cloths for high-gloss surfaces.
- Do not allow water to penetrate the device.
- Do not clean the device in a dishwasher.
- Do not use sharp, pointed, abrasive or corrosive cleaning materials or hard brushes.
- Do not use chemicals.
- Do not use flammable liquids for cleaning the device.

2.8. Information on device disposal



Important: The EU Directive 2012/19/EU regulates the proper return, treatment and recycling of used electronic devices. This symbol means that in the interest of environmental protection the device must be disposed of separately from household or industrial waste at the end of its service life in accordance with applicable local legal guidelines. Disposing of used devices can be done at official recycling centers in your country. Obey local regulations when disposing of material. Further details on returns

(also for non-European countries) can be obtained at your local authority. Separate collection and recycling saves natural resources and ensures that all the provisions for protecting health and environment are observed when recycling the product.

3. Product introduction

3.1. Scope of delivery

- ABUS Z-Wave Magnetic Contact & Battery
- Quickguide & Safety instructions

3.2. Device features

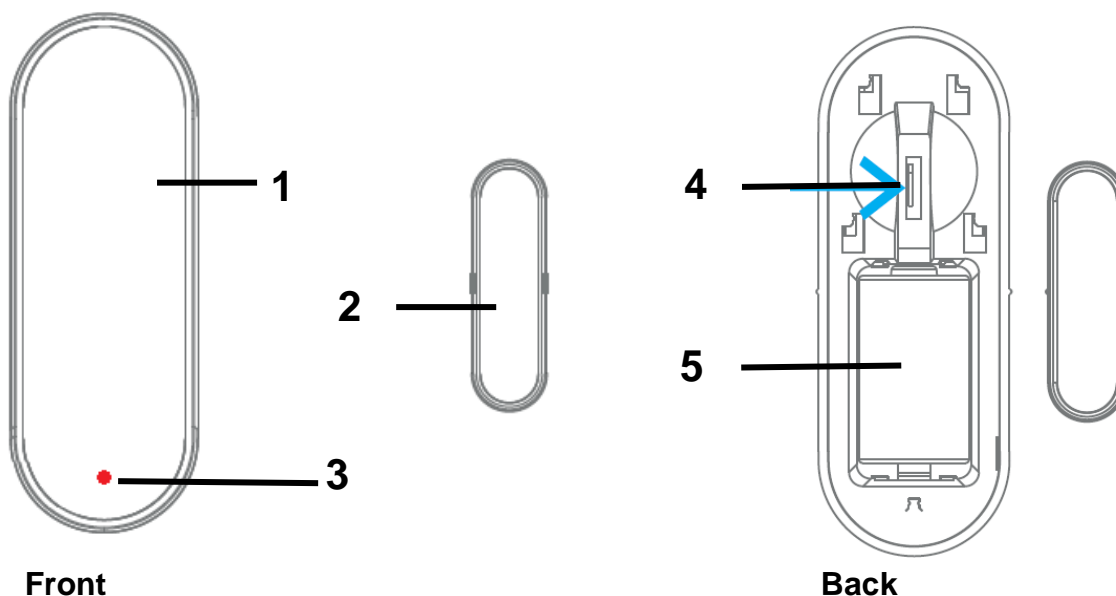

Nr	Label	Comment
1	Device	
2	Magnet	
3	Status-LED	Serves as status display for various processes
4	Tamper-Button	For inclusion / exclusion of the detector in a Z-Wave gateway, factory reset and tamper alarm
5	Battery case	For CR2 Batterien (3V DC)

3.3 Operating principle

The SHMK10000 was developed for use in home automation systems that use the Z-Wave wireless standard. The sensor enables the monitoring of windows and doors and can be installed comfortably without drilling and wiring thanks to battery operation and adhesive mounting. When the battery level is low, the detector automatically gives feedback to the gateway.

In conjunction with configurable scenes, smart functions can also be initiated in addition to monitoring, e.g. door open, light on. The integrated sabotage button also reliably reports possible manipulation attempts to the gateway.

3.3. Performance features

The ABUS Z-Wave SHMK10000...:

- ...is a battery-operated radio magnetic contact
- ...is Z-Wave PLUS compatible & certified
- ...supports the Z-Wave S2 Standard (Security 2)
- ...detects opening/closing by removing sensor and magnet
- ...detects tampering when the housing is opened
- ...has a battery-empty warning function
- ...was developed for indoor installation

3.4. Use in systems of different manufacturers

Communication is via the Z-Wave EU frequency (868.42 Mhz). You can integrate the device into any Z-Wave network with a certified Z-Wave gateway, regardless of manufacturer. All non-battery powered nodes in the network act as repeater to increase the durability of the network.

4. Overview of functions

4.1. Inclusion / Add Device

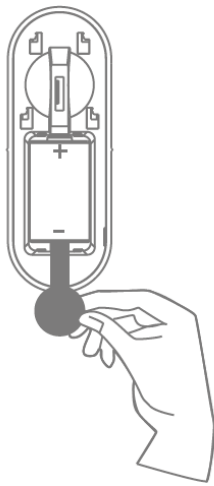
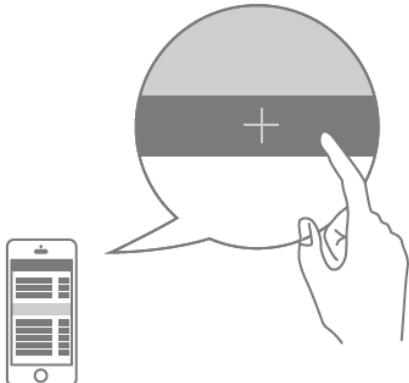
<p>A</p> 	<p>Slide the base unit from the mounting plate and remove the safety strip from the battery compartment</p>
<p>B</p> 	<p>Click the + (Add) button in your Z-Wave App and follow the further instructions</p>

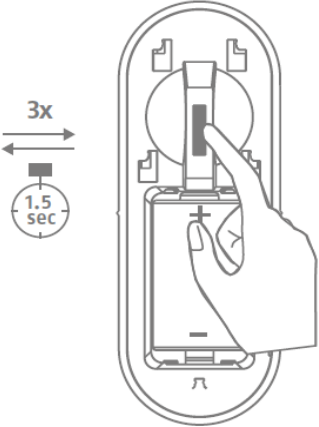
<p>C</p> 	<p>Press the Tamper-button 3 times within 1.5 seconds and the Status-LED on the base unit front will flash 3 times</p> <p>The App will show if the Add device process was successful and the Status-LED will turn off</p> <p>Repeat the inclusion process from step B if it was not successful.</p>
---	---

4.2. Mounting & Installation

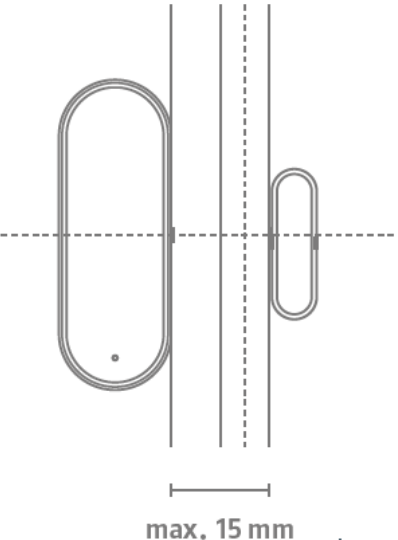
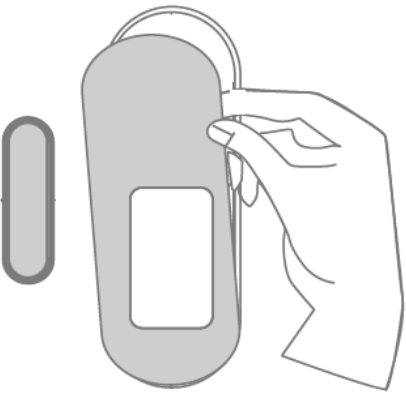
<p>A</p>  <p>max. 15 mm</p>	<p>Test the release behaviour at the desired mounting position in advance.</p> <p>The magnet should be mounted no more than 15 mm from the sensor.</p> <p>Note: Do not mount the detector... ...on or near metal surfaces! ...in close proximity (< 1m) to gas, water and power lines! ...near electrical devices e.g. PC, copier or other transmitters</p> <p>Installation site: Optimum mounting location for the door, window contact is the upper corner of your window or door frame.</p>
<p>B</p> 	<p>Remove the adhesive strip cover from the sensor and magnets and attach it to the desired mounting position.</p> <p>The magnet can be mounted to the right or left of the sensor.</p>

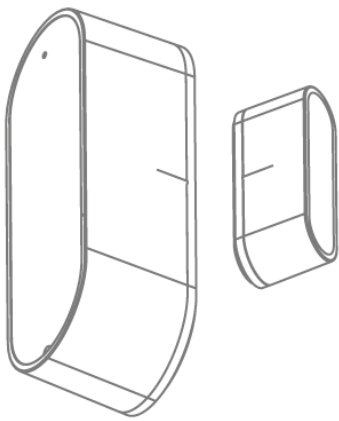
<p>C</p> 	<p>Center the magnet on the sensor (see marking strip).</p> <p>When the sensor is opened or closed, the status LED lights up once.</p>
---	--

4.3. Exclusion / Remove Device

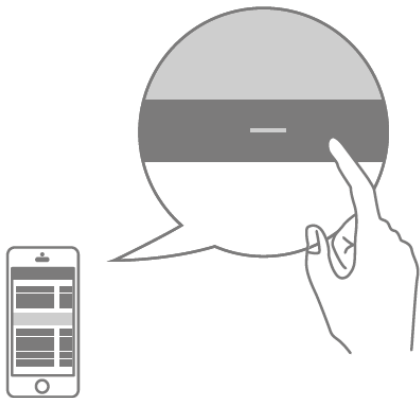
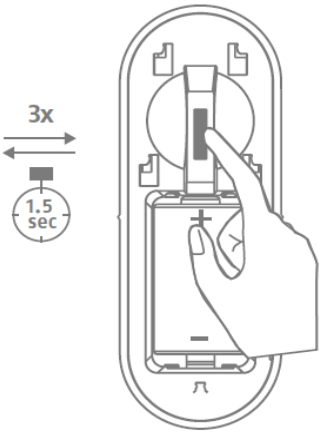
<p>A</p> 	<p>Click the - (Remove) button in your Z-Wave App and follow the further instructions</p>
<p>B</p> 	<p>Press the Tamper-button 3 times within 1.5 seconds and the Status-LED on the base unit front will flash 3 times</p> <p>The App will show if the Remove device process was successful and the Status-LED on device will flash 6 times</p> <p>Repeat the exclusion process from step A if it was not successful.</p>

4.4. Reset (Factory-Reset)

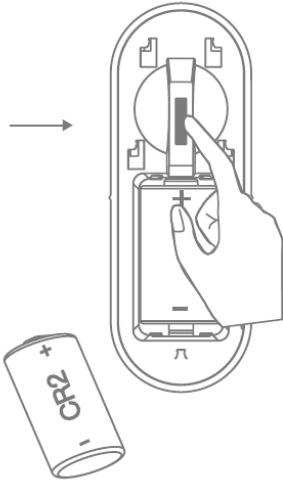
	<ol style="list-style-type: none"> 1. Press the Tamper-button 3 times within 1.5 Seconds 2. The device is now restored to factory settings <p>Note:</p> <ol style="list-style-type: none"> 1, This procedure should only be used if the primary gateway is not capable of acting. 2, If the multi-sensor is set to the factory setting, the status is set to "not included", the association settings and possible configurations are reset to default.
---	--

5. Advanced Z-Wave Parameter

5.1. Association Group Information

Z-Wave devices can control other devices directly. This direct control is called in Z-Wave association. For this purpose, the device ID of the device to be controlled must be stored in the controlling devices. This is done in so-called association groups. An association group is always linked to an event in the controlling device (pressing a key or triggering a sensor). When this event occurs, a control command - usually a BASIC SET - is sent to all devices stored in an association group.

The magnetic contact supports the following association group:

Group Number	Maximum Devices	Transmitted Content
Group 1	0x05	Lifeline association group Include command classe: Battery report, Notification report, and Device Reset Locally notification, Binary report.
Group 2	0x05	Root Device group(Binary Sensor) Binary Sensor Command Class:Compatible with 300 series 1-Binary Sensor reports status of open or close door via Lifeline. 2-When the sensor detects status change between close door and open door, the device will be triggered.
Group 3	0x05	Root Device group(Binary Sensor) Binary Sensor Command Class:Compatible with 300 series 1-Binary Sensor reports the removed status of door sensor. 2-When the sensor detects status change of tamper, the device will be triggered.
Group 4	0x05	Root Device group(Notification) 1-Notification report open door or close status via Lifeline.

		2- When the sensor detects status change between close door and open door, the device will be triggered.
Group 5	0x05	Root Device group(Notification) 1-Binary Sensor reports the removed status of door sensor. 2- When the sensor detects status change of tamper, the device will be triggered.

5.2. Supported Command Classes

- 1 Z-Wave plus Info Version 2
- 2 Notification Version 8
- 3 Association Version 2
- 4 Association Group Info Version 1
- 5 Transport Service Version 2
- 6 Version Version 3
- 7 Manufacturer Specific Version 2
- 8 Device Reset Locally Version 1
- 9 Powerlevel Version 1
- 10 Battery Version 1
- 11 Security 2 Version 1
- 12 Supervision Version 1
- 13 Wake Up Version 2

6. Technical Specifications

Parameters	Unit	SHMK10000
Dimensions	mm	72 x 21 x 26 (Sensor) / 35 x 11 x 13 (Magnet)
Weight	g	45
Operating Temperature	°C	0 – 40
Max. Humidity	%	95
IP Class		20
Radio frequency	MHz	868,42 (Z-Wave PLUS, Europe)
Modulation		FSK/GFSK
Transmission power	db	< 4,5
Power supply		3 V DC
Battery type		CR2
Power consumption standby	mA	0,005
Power consumption trigger	mA	38
Battery-life		3 Years (10 triggers per day)
Range (open field)	m	100
Range (building)	m	20, related to material of walls
Tamper protection		Yes
Firmware updateable		No
Support Z-Wave Beaming		No
SmartStart supported		No
Z-Wave Network Security		Yes
Z-Wave AES-128 Security		Yes
Z-Wave Plus		Yes

Security S2 Classes		Yes
Z-Wave Chip Generation		500
Z-Wave Sensor-Typ		Open/Closed (Binary)
Zwave library type		Routing Slave
Device Type / Role type		Notification sensor / Reporting sleeping slave