

The Motion Sensor is a Z-Wave™ enabled device which is fully compatible with any Z-Wave™ enabled network. The device can be set up in a Z-Wave network to communicate directly with other end devices such as switches or dimmers, or to connect to a Z-Wave controller such as Eaton's Home Automation Hub or other Z-Wave certified controllers.

This product supports the S2 security protocol that uses encrypted Z-Wave Plus messages to communicate to other security-enabled Z-Wave products. A security-enabled Z-Wave Plus Controller must be used in order to fully utilize the security features of this product.

The Motion Sensor is designed with two detecting sensors, Passive Infra-Red (PIR) sensor and ambient light sensor, in order to optimize its performance for both security and home automation applications. For security applications, the sensor will transmit a signal to a controller when any motion is detected within the device's field of view which could trigger an alarm or some other notification. For home automation, the sensor can be used turn lights ON or OFF as someone enters or leaves a room or area. It includes a timeout timer that can automatically turn lights OFF when it no longer detects motion after a configurable amount of time. The light sensor allows the system to be configured to implement different actions based on the ambient light level (such day vs. night).

The Motion Sensor uses a CR123 3.0V Lithium battery, which under normal conditions, will have a battery life of up to 2 years. When the battery level drops to an unacceptable level, the sensor will emit a low battery message to the Z-Wave controller. When this occurs the batteries should be replaced as soon as possible

Product Overview

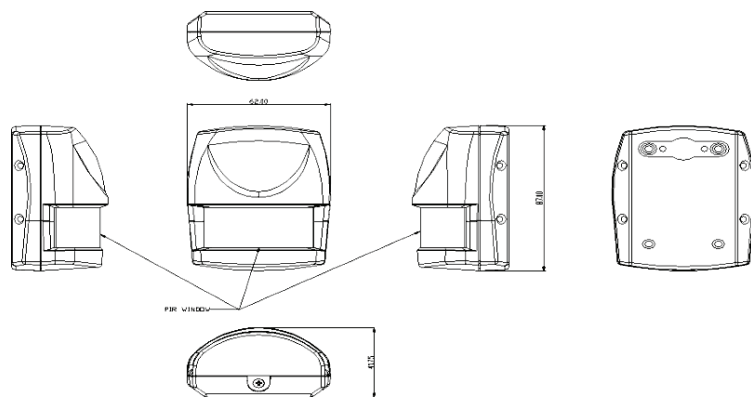

Installing and Adding to Z-Wave™ Network

Auto Inclusion
The sensor supports Auto Inclusion feature where it will automatically enter Inclusion mode when first powered up after a factory reset.
1. Use a screwdriver to detach the rear cover.

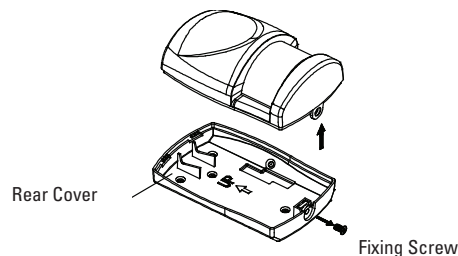

2. Put a Z-Wave Controller into inclusion mode.
3. Insert 1 CR123 3V battery to the battery compartment with the correct polarity.
The LED on the device should turn ON.

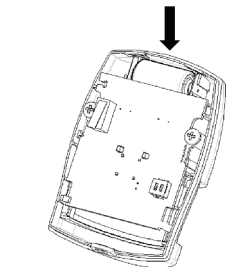

4. The Inclusion process should be completed when the LED stops blinking.
5. Do not refit the rear cover yet and proceed to the Testing section before mounting.
Note: If Auto Inclusion fails, refer to the Troubleshooting section regarding Manual Inclusion.

Testing Warm-Up

It will take approximately 2 minutes for the sensor to warm up after a battery is inserted. During this period the LED behind the lens will turn ON. When the red LED turns OFF, it implies that the warm-up procedure is completed and the sensor is ready for detection.

Note: This will not affect the Inclusion/Exclusion process.
Note: After removing batteries, wait for 5 seconds to refit batteries.

Quick Test

Prior to mounting the device, it is recommended that device is placed in test mode to find the optimal positioning of the sensor

1. If the rear cover is attached, remove the rear cover using a screwdriver.
2. With the rear cover detached, the tamper switch will be in the open position, and the unit will enter Test Mode.
3. During Test Mode, if movement is detected, the LED on the sensor will light up once implying the unit is working properly, and it will retrigger about every 5 seconds if motion is detected. During this mode, you can also test the range and positioning to make sure it is placed in an optimal location (see Choosing the Location section).
4. To exit the Test mode, simply press the Tamper switch for more than 10 seconds or simply replace the rear cover which causes the Tamper switch to be depressed.
5. During normal mode, when PIR is triggered, the red LED will not light up and retrigger time is based on set up value.

Mounting the Sensor

Choosing the location

The PIR Sensor is suitable for mounting in dry indoor locations only.
The recommended position for a PIR Sensor is in the corner of a room mounted at a height between 1.8m (5.9ft) and 2m (6.6ft). At this height, the sensor will have a maximum range of up to 9m (29.5ft) with a field of view of 120°, subject to the position for the sensor being set in position 5. (see FIGURES 1 & 2)
The position of the PCB inside the sensor can be set to 5 different positions to adjust the range of the sensor. Setting the PCB in position 3 will reduce the range to approximately 6m (19.7ft), with position 1 providing a range of approximately 3m (9.8ft). The recommended position setting for the sensor is in position 5. The position should be set based on the desired range of the user.

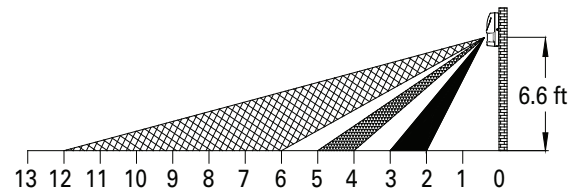

Figure 1

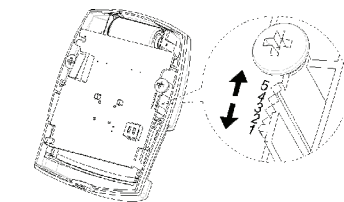

Figure 2

When determining the mounting position for the sensor the following points should be considered to ensure trouble-free operation:

1. **Do not** locate the sensor facing a window or where it is exposed to or facing direct sunlight.
2. **Do not** locate the sensor near air vents.
3. **Do not** locate the sensor directly above a heat source, (e.g. fire, radiator, boiler, etc).
4. **Do not** locate the detector in a position where it is subject to excessive vibration
5. Where possible, mount the sensor in the corner of the room so that the logical path of a person would cut across the fan detection pattern. PIR sensors respond more effectively to movement across the device than to movement directly towards it. (FIGURE 3).

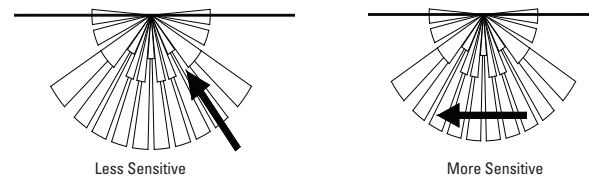

Figure 3

6. Ensure that the position selected for the PIR sensor is within effective range of the system, (refer to System Installation and Operating Manual).

Installation

Before mounting, ensure that the sensor PCB position is set to the correct position to provide the desired detection range. To adjust the range, simply slide the PCB up or down ensuring the position legs are aligned with the required position number marked on the board.
The Motion Sensor can be mounted using either the provided dual-sided adhesive or screws.

For installation using dual-sided adhesive:

1. Remove one side of the adhesive cover and attach appropriately to the rear of the device. For corner mounting, it is recommended to cut the adhesive into two pieces and place on each angled side to ensure a better fit.
2. Remove the other side of the adhesive cover, place the device in its desired location, and apply pressure until the device is secure.

For installation using screws:

1. Carefully drill out the required mounting holes in the rear cover using 3mm drill according to whether the unit is being mounted in a corner or against a flat wall.
- Note:** Use the 1st mounting hole positions for corner mounting installation, and use the 2nd mounting hole positions for flat wall installation. (see FIGURE 4a & 4b)

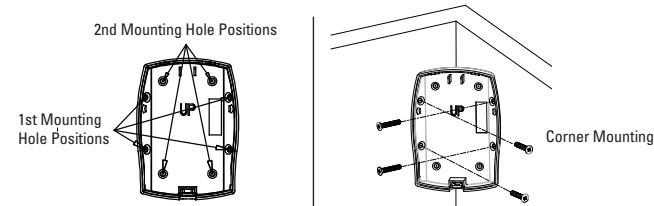

Figure 4a

Figure 4b

2. Using the rear cover as a template, mark the positions of the fixing holes on the wall.
3. Fix the rear cover to the wall using the two 18mm No.4 screws and 25mm wall anchors, (a 5mm hole will be required for the wall anchors). Do not over-tighten the fixing screws as this may distort or damage the cover.
4. Fit the sensor onto the rear cover by placing the clips on the top edge into the rear cover. Push the lower edge of the sensor into place and refit the fixing screw in the bottom edge of the sensor to secure in position. Do not over-tighten the fixing screws as this may damage the casing.
Once the device is mounted and installed in a Z-Wave network, ensure that motion is properly detected and the associated devices and/or controller are activated appropriately.

Programming Z-Wave Group

The sensor supports either one of two Z-Wave Association Groups:

- Group 1:** Association with 1 Controller node.
- Group 2:** Association with 4 nodes (i.e. end devices such as switches or dimmers). This allows the sensor to transfer commands directly to end devices without having to go through the controller.

- Group 1 commands:
- When the unit is powered up and is already a part of a Z-Wave network, the unit will send a Notification Report to the node in Group 1.
 - When the unit senses motion, the unit will send a Notification Report to the nodes of Group 1. Once the movement is stopped, a Notification Report will be sent again to Group 1.
 - When the sensor status changes, the unit will check its battery status simultaneously. When the battery level of the unit is low, the unit will emit a Battery report to the nodes of Group 1
 - When performing Factory Reset the unit will send Device Reset Locally Notification to the node of Group 1.
- Group 2 commands:
- When the sensor is triggered, the unit will send BASIC_SET command which contains a value to the nodes of Group 2.

AGI (Association Group Information) Table

Group	Profile	Command Class & Command (List) N bytes		Group Name(UTF-8)
1	General	Battery Report, Notification Report Device Reset Locally Notification		Lifeline
2	Control	Basic Set		PIR Control

Notification

Event	Type	Event	Event Parameters Length	Event Parameters
The power is applied for the first time	0x08	0x01	0x00	—
PIR Trigger ON	0x07	0x08	0x00	—
PIR Trigger OFF	0x07	0x00	0x01	0x08
Tamper switch being pressed more than 10 seconds	0x07	0x00	0x01	0x03
Tamper switch being pressed more than 10 seconds and released	0x07	0x03	0x01	—

Battery

Battery Report (value)	Description			
20 - 100	Battery Level (%)			
0xFF	Low Battery			

WakeUp Command Class

After it has been included into a Z-Wave network, the sensor will go to sleep but will send a Wakeup Notification Command periodically at preset interval to the controller. The Motion sensor will stay awake for at least 10 seconds and then go back to sleep to conserve battery life.
The time interval between Wakeup Notification Commands can be set in the Wakeup Command Class based on the range values below:

Minimum Wake Up Interval	600s (10 minutes)
Maximum Wake Up Interval	86400s (1 day)
Default Wake Up Interval	14400s (4 hours)
Wake Up Interval Step Seconds	600s (10 minutes)

Z-Wave's Configuration Parameters

The following information is for someone that has some experience in setting up a Z-Wave system or someone that has computer software running a Z-Wave controller. Please get familiar with software of Z-Wave controller before getting started.

To save power for the battery, the motion sensor is normally in sleep mode. In order to wake the device up, press the tamper switch once. This will keep the device awake for 30 seconds indicated by the LED blinking every second. During this time, the user can change configuration parameters from the controller software. If more time is needed, continue pressing the tamper switch every 30 seconds.

1. Basic Set Level

The Basic Set Level determines the value that will be sent from the Basic Set command for devices associated with Group 2. For a Binary Switch Device (e.g., receptacle or appliance module), it will be a simple ON command. For a Multilevel Switch Device (e.g., a dimmer), it will be set to the level set by this parameter.

Example:

1-99: ON (Binary Switch Device)

Dim Level (Multilevel Switch Device)

Function	Parameter Number	Size	Range	Default
Basic Set level	1	1	1 ~ 99	99

2. Sensitivity Level (PIR sensor only)

In order to provide the best efficiency of the sensor, it is recommended to test the sensor with movements from the farthest end of the coverage area at first time of use. If movements cannot be detected consistently, simply adjust the sensitivity level with Configuration Parameter #3. This parameter can be configured with the value of 1 through 10, where 1 means low sensitivity and 10 means high sensitivity.

Function	Parameter Number	Size	Range	Default
Sensitivity Level	3	1	1 ~ 10	6

3. Re-trigger Interval Setting (PIR sensor only)

The Re-trigger Interval Setting determines the amount of time between when the sensor will re-trigger a signal that motion has been detected. During this time, the sensor will not report motion even though motion may be detected. The time interval can be set between 5 secs to 3600 secs.

Function	Parameter Number	Size	Range	Default
Re-trigger Interval	4	2	5-3600 (sec)	180



4. Lux Level

The user can set a lux level percentage which determines when the light sensor will be activated. If the lux level of ambient illumination falls below this percentage, and motion is detected, the sensor will emit a Z-Wave ON Command to the controller. Percentage can be set between 1% to 100%.

Function	Parameter Number	Size	Range	Default
Lux Level	35	1	1 ~ 100%	20

5. On-Off Duration

The function of on-off duration setting will be useful if the detector is connected with a module or lighting. The duration determines how long the module/lighting should stay ON. For instance, Lamp Module turns OFF 100 secs after it has been turned ON. This parameter can be configured with the value of 5 through 3600, where 5 means 5 second delay and 3600 means 3600 seconds of delay.

Function	Parameter Number	Size	Range	Default
ON-OFF Duration	6	2	5-3600 (sec)	15

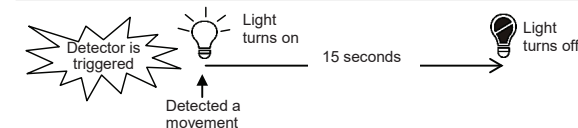

Troubleshooting Guides

The table below lists the several steps involved when adding or removing the unit from the Z-Wave network.

Action/Status	Description	LED indication
No node ID	The Z-Wave Controller does not allocate a node ID to the unit	2-second ON, 2-second OFF for 2 minutes
Auto Inclusion	The power is applied for the first time and no node ID has been stored in the module, or after executing reset	
Manual Inclusion	1. Put the Z-Wave Controller into Inclusion mode 2. Press the tamper switch 3 times within 1.5 seconds to put the unit into inclusion mode	
Exclusion	1. Put the Z-Wave Controller into Exclusion mode 2. Press the tamper switch 3 times within 1.5 seconds to put the unit into exclusion mode	
Factory Reset (This procedure should only be used when the controller is inoperable)	1. Press the tamper switch 3 times within 1.5 seconds to put the unit into exclusion mode 2. Within 1 second of step 1, press the tamper switch again and hold until LED is off (about 5 seconds) 3. Node ID is excluded. The device reverts to factory default state and will be in auto-inclusion mode for 4 minutes	2-second ON, 2-second OFF for 2 minutes

* Failed or successful results in including/excluding the ID can be viewed on the Z-Wave Controller.

Note: If you are connecting this unit to a Z-wave Controller that utilizes the S2 security protocol, you may be asked to enter a 5 digit Device Specific Key (DSK) that is unique to each unit by your controller. This can be found in one of two places:

- on the QR code label on the back of the unit
- on the insert card inside the packaging

The table below lists typical problems encountered:

Symptoms	Possible Cause	Solution
Cannot carry out inclusion and association	1. Run out of battery power 2. Reverse battery polarity 3. Sensor is out of order	1. Replace a new battery 2. Refit the battery with correct polarity 3. Ensure the sensor is working properly
Cannot control the connected modules	1. Run out of battery power 2. Sensor is out of order	1. Replace a new battery 2. Ensure the sensor is working properly
The sensor is not working	1. Run out of battery power 2. Check if the mounting location is proper 3. Check if the sensor is mounted above a radiator or heater 4. Sensor is out of order	1. Replace a new battery 2. Reposition its mounting location 3. Remove the source of interference or reposition its mounting location 4. Ensure the sensor is working properly

Specifications

Battery	CR123 3.0V 1700mAh Lithium Battery
Battery Life	2 year*
Range	Up to 100 meters line of sight
Warm Up Time	About 2 minutes
PIR Detection Coverage	Up to 10m x 110° (at 1.8m mounting height & 25°C)
Operating Frequency	908.42 MHz
FCC ID	UH2-RF96PIRBMS
IC	4706C-RF96PIRBMS

* Specifications are subject to change without notice * measured at 10 triggers per day



FCC STATEMENT

This device complies with Part 15 of the FCC Rules. Operation is subject to the following two conditions:

- 1: This device may not cause harmful interference, and
- 2: This device must accept any interference received, including interference that may cause undesired operation.

NOTE: This equipment has been tested and found to comply with the limits for a Class B digital device, pursuant to Part 15 of the FCC Rules. These limits are designed to provide reasonable protection against harmful interference in a residential installation. This equipment generates, uses and can radiate radio frequency energy and, if not installed and used in accordance with the instructions, may cause harmful interference to radio communications. However, there is no guarantee that interference will not occur in a particular installation. If this equipment does cause harmful interference to radio or television reception, which can be determined by turning the equipment off and on, the user is encouraged to try to correct the interference by one or more of the following measures:

- Reorient or relocate the receiving antenna.
- Increase the separation between the equipment and receiver.
- Connect the equipment into an outlet on a circuit different from that to which the receiver is connected.
- Consult the dealer or an experienced radio/TV technician for help.

FCC CAUTION:

Any changes or modifications not expressly approved by Eaton Wiring Devices could void the user's authority to operate the equipment This device complies with Industry Canada's license-exempt RSSs. Operation is subject to the following two conditions:

- (1) This device may not cause interference; and
- (2) This device must accept any interference, including interference that may cause undesired operation of the device.

RADIATION EXPOSURE STATEMENT:

This equipment complies with FCC radiation exposure limits set forth for an uncontrolled environment. This equipment should be installed and operated with minimum distance 20cm between the radiator & your body.

INDUSTRY CANADA STATEMENT:

This device complies with ISED's licence-exempt RSSs. Operation is subject to the following two conditions: (1) This device may not cause harmful interference, and (2) this device must accept any interference received, including interference that may cause undesired operation.

Le présent appareil est conforme aux CNR d'ISED applicables aux appareils radio exempts de licence. L'exploitation est autorisée aux deux conditions suivantes : (1) le dispositif ne doit pas produire de brouillage préjudiciable, et (2) ce dispositif doit accepter tout brouillage reçu, y compris un brouillage susceptible de provoquer un fonctionnement indésirable.

RADIATION EXPOSURE STATEMENT:

This equipment complies with ISED radiation exposure limits set forth for an uncontrolled environment. This equipment should be installed and operated with minimum distance 20cm between the radiator & your body.

DECLARATION D'EXPOSITION AUX RADIATIONS:

Cet équipement est conforme aux limites d'exposition aux rayonnements ISED établies pour un environnement non contrôlé. Cet équipement doit être installé et utilisé avec un minimum de 20 cm de distance entre la source de rayonnement et votre corps.

WARNING:

Do not dispose of electrical appliances as unsorted municipal waste, use separate collection facilities. Contact your local government for information regarding the collection systems available. If electrical appliances are disposed of in landfills or dumps, hazardous substances can leak into the groundwater and get into the food chain, damaging your health and well-being. When replacing old appliances with new ones, the retailer is legally obligated to take back your old appliance for disposal at least for free of charge.

EATON WIRING DEVICES LIMITED 2 YEAR WARRANTY

Eaton Wiring Devices warrants its switch to be free of defects in materials and workmanship in normal use and service for a period of two years from date of original purchase. THIS TWO (2) YEAR LIMITED WARRANTY IS IN LIEU OF ALL OTHER WARRANTIES, OBLIGATIONS, OR LIABILITIES, EXPRESSED OR IMPLIED (INCLUDING ANY IMPLIED WARRANTY OF MERCHANTABILITY OR FITNESS FOR A PARTICULAR PURPOSE THAT IS IN DURATION IN EXCESS OF TWO YEARS FROM THE DATE OF ORIGINAL CONSUMER PURCHASE). NO AGENT, REPRESENTATIVE, OR EMPLOYEE OF EATON HAS AUTHORITY TO INCREASE OR ALTER THE OBLIGATIONS OF EATON UNDER THIS WARRANTY.

To obtain warranty service for any properly installed Eaton switch that proves defective in normal use send the defective switch prepaid and insured to Quality Control Dept., Eaton Wiring Devices, 203 Cooper Circle, Peachtree City, GA 30269; in Canada: Eaton Wiring Devices, 5925 McLaughlin Road, Mississauga, Ontario L5R 1B8. Eaton will repair or replace the defective unit, at its option. Eaton will not be responsible under this warranty if examination shows that the defective condition of the unit was caused by misuse, abuse, improper installation, alteration, improper maintenance or repair of damage in shipment to Eaton. EATON SHALL HAVE NO RESPONSIBILITY FOR INSTALLATION OF THE SWITCH, OR FOR ANY PERSONAL INJURY, PROPERTY DAMAGE, OR ANY SPECIAL, INCIDENTAL, CONTINGENT, OR CONSEQUENTIAL DAMAGES OF ANY KIND, RESULTING FROM DEFECTS IN THE SWITCH OR FOR BREACH OF ANY EXPRESS OR IMPLIED WARRANTY ON THIS PRODUCT.

THE EXCLUSIVE REMEDY FOR BREACH OF THE LIMITED WARRANTY CONTAINED HEREIN IS THE REPAIR OR REPLACEMENT OF THE DEFECTIVE PRODUCT AT EATON'S OPTION. IMPLIED WARRANTIES (IF ANY) INCLUDING, BUT NOT LIMITED TO IMPLIED WARRANTIES OF FITNESS FOR A PARTICULAR PURPOSE AND MERCHANTABILITY, ARE LIMITED IN DURATION TO A PERIOD ENDING TWO YEARS FROM THE DATE OF ORIGINAL CONSUMER PURCHASE. IN NO CASE SHALL EATON'S LIABILITY UNDER ANY OTHER REMEDY PRESCRIBED BY LAW EXCEED THE PURCHASE PRICE. Some states do not allow the exclusion or limitation of incidental or consequential damages or allow disclaimers or modifications of or limitations on how long an implied warranty lasts, so the above limitations may not apply to you. Some Canadian provinces do not allow exclusion or variance of implied warranties so that some or all of the above limitations may not apply to you. This warranty gives you specific legal rights and you may also have other rights which vary from state to state and province to province.

Read enclosed instructions carefully. If you have any questions concerning use or care of this product, please write: Consumer Service Division, Eaton Wiring Devices, 203 Cooper Circle, Peachtree City, GA 30269.