

## **AXIS M5000-G PTZ Camera**

## **User Manual**

# AXIS M5000-G PTZ Camera

## Table of Contents

---

<b>Installation</b> .....	3
<b>Get started</b> .....	4
Find the device on the network .....	4
Access the device .....	4
Webpage overview .....	5
<b>Configure your device</b> .....	8
Adjust the image .....	8
Adjust the camera view (PTZ) .....	11
View and record video .....	12
Set up rules for events .....	13
Audio .....	17
<b>Cleaning recommendations</b> .....	18
<b>Learn more</b> .....	19
Capture modes .....	19
Privacy masks .....	19
Overlays .....	20
Pan, tilt, and zoom (PTZ) .....	20
Wireless I/O (Z-Wave Plus™ v2) .....	20
Streaming and storage .....	24
Applications .....	26
<b>Troubleshooting</b> .....	28
Reset to factory default settings .....	28
Firmware options .....	28
Check the current firmware version .....	28
Upgrade the firmware .....	28
Technical issues, clues, and solutions .....	29
Performance considerations .....	30
Contact support .....	31
<b>Specifications</b> .....	32
Product overview .....	32
LED indicators .....	32
SD card slot .....	33
Buttons .....	33
Connectors .....	33

# AXIS M5000-G PTZ Camera

## Installation

---

### Installation



To watch this video, go to the web version of this document.

*[help.axis.com/?&pid=70613&section=install](http://help.axis.com/?&pid=70613&section=install)*

*How to install the product*



To watch this video, go to the web version of this document.

*[help.axis.com/?&pid=70613&section=install](http://help.axis.com/?&pid=70613&section=install)*

*How to install the product with a ceiling mount*

# AXIS M5000-G PTZ Camera

## Get started

---

### Get started

#### Find the device on the network

To find Axis devices on the network and assign them IP addresses in Windows®, use AXIS IP Utility or AXIS Device Manager. Both applications are free and can be downloaded from [axis.com/support](http://axis.com/support).

For more information about how to find and assign IP addresses, go to *How to assign an IP address and access your device*.

#### Browser support

You can use the device with the following browsers:

	Chrome™	Firefox®	Edge™	Safari®
Windows®	recommended	recommended	✓	
macOS®	recommended	recommended	✓	✓
Linux®	recommended	recommended	✓	
Other operating systems	✓	✓	✓	✓*

\*To use AXIS OS web interface with iOS 15 or iPadOS 15, go to **Settings > Safari > Advanced > Experimental Features** and disable *NSURLSession Websocket*.

If you need more information about recommended browsers, go to *AXIS OS Portal*.

#### Access the device

1. Open a browser and enter the IP address or host name of the Axis device.  
If you do not know the IP address, use AXIS IP Utility or AXIS Device Manager to find the device on the network.
2. Enter the username and password. If you access the device for the first time, you must set the root password. See *Set a new password for the root account on page 4*.
3. The live view page opens in your browser.

#### Verify that no one has tampered with the firmware

To make sure that the device has its original Axis firmware, or to take full control of the device after a security attack:

1. Reset to factory default settings. See *Reset to factory default settings on page 28*.  
After the reset, secure boot guarantees the state of the device.
2. Configure and install the device.

#### Set a new password for the root account

##### Important

The default administrator username is **root**. If the password for root is lost, reset the device to factory default settings. See *Reset to factory default settings on page 28*.

# AXIS M5000-G PTZ Camera

## Get started

---



To watch this video, go to the web version of this document.

[help.axis.com/?&pid=70613&section=set-a-new-password-for-the-root-account](https://help.axis.com/?&pid=70613&section=set-a-new-password-for-the-root-account)

*Support tip: Password security confirmation check*

1. Type a password. Follow the instructions about secure passwords. See *Secure passwords on page 5*.
2. Retype the password to confirm the spelling.
3. Click **Create login**. The password has now been configured.

### Secure passwords

#### Important

Axis devices send the initially set password in clear text over the network. To protect your device after the first login, set up a secure and encrypted HTTPS connection and then change the password.

The device password is the primary protection for your data and services. Axis devices do not impose a password policy as they may be used in various types of installations.

To protect your data we strongly recommend that you:

- Use a password with at least 8 characters, preferably created by a password generator.
- Don't expose the password.
- Change the password at a recurring interval, at least once a year.

# AXIS M5000-G PTZ Camera

## Get started

---

### Webpage overview



- 1 Live view control bar
- 2 Live view
- 3 Product name
- 4 User information, color themes, and help
- 5 Video control bar

# AXIS M5000-G PTZ Camera

## Get started

---

6 Settings toggle

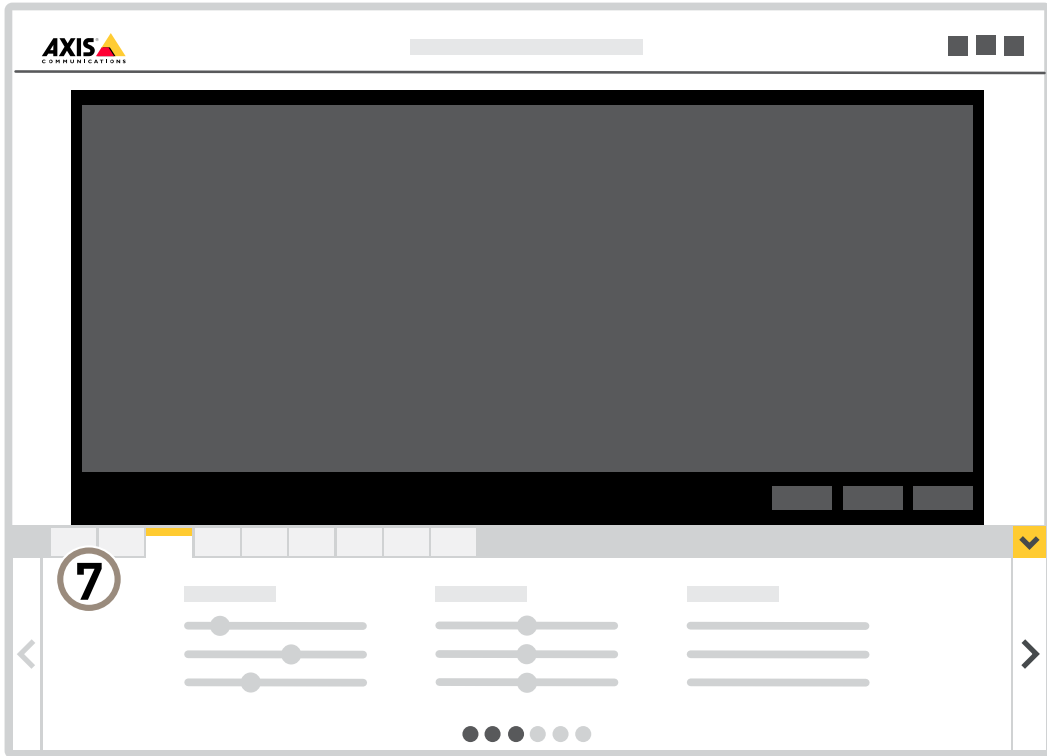

7 Settings tabs

# AXIS M5000-G PTZ Camera

## Configure your device

---

### Configure your device

#### Adjust the image

This section includes instructions about configuring your device. If you want to learn more about how certain features work, go to *Learn more on page 19*.

#### Select exposure mode

There are different exposure mode options in the camera that adjusts aperture, shutter speed, and gain to improve image quality for specific surveillance scenes. Go to **Settings > Image > Exposure** and select between the following exposure modes:

- For most use cases, select **Automatic** exposure.
- For environments with certain artificial lighting, for example fluorescent lighting, select **Flicker-free**.  
Select the same frequency as the power line frequency.
- For environments with certain artificial light and bright light, for example outdoors with fluorescent lighting at night and sun during daytime, select **Flicker-reduced**.  
Select the same frequency as the power line frequency.
- To lock the current exposure settings, select **Hold current**.

#### Benefit from IR light in low-light conditions using night mode

Your camera uses visible light to deliver color images during the day. As the available light diminishes, you can set the camera to automatically shift to night mode, in which the camera uses both visible light and near-infrared light to deliver black-and-white images. Since the camera uses more of the available light it can deliver brighter, more detailed, images.

1. Go to **Settings > Image > Day and night**, and make sure that the **IR cut filter** is set to **Auto**.

#### Reduce noise in low-light conditions

To reduce noise in low-light conditions, you can adjust one or more of the following settings:

- Adjust the trade-off between noise and motion blur. Go to **Settings > Image > Exposure** and move the **Blur-noise trade-off** slider toward **Low noise**.
- Set the exposure mode to automatic.

##### Note

A high max shutter value can result in motion blur.

- To slow down the shutter speed, set max shutter to the highest possible value.
- Reduce sharpness in the image.

##### Note

When you reduce the max gain, the image can become darker.

- Set the max gain to a lower value.
- Open the aperture.

#### Reduce motion blur in low-light conditions

To reduce motion blur in low-light conditions, adjust one or more of the following settings in **Settings > Image > Exposure**:



# AXIS M5000-G PTZ Camera

## Configure your device

---

- Move the **Blur-noise trade-off** slider toward **Low motion blur**.

### Note

When you increase the gain, image noise also increases.

- Set **Max shutter** to a shorter time, and **Max gain** to a higher value.

If you still have problems with motion blur:

- Increase the light level in the scene.
- Mount the camera so that objects move toward it or away from it rather than sideways.

### Handle scenes with strong backlight

Dynamic range is the difference in light levels in an image. In some cases the difference between the darkest and the brightest areas can be significant. The result is often an image where either the dark or the bright areas are visible. Wide dynamic range (WDR) makes both dark and bright areas of the image visible.



*Image without WDR.*



*Image with WDR.*

### Note

- WDR can cause artifacts in the image.
  - WDR may not be available for all capture modes.
1. Go to **Settings > Image > Wide dynamic range**.
  2. Turn on WDR.
  3. Use the **Local contrast** slider to adjust the amount of WDR.
  4. If you still have problems, go to **Exposure** and adjust the **Exposure zone** to cover the area of interest.

Find out more about WDR and how to use it at [axis.com/web-articles/wdr](https://axis.com/web-articles/wdr).

# AXIS M5000-G PTZ Camera

## Configure your device

---

### Verify the pixel resolution

To verify that a defined part of the image contains enough pixels to, for example, recognize the face of a person, you can use the pixel counter.

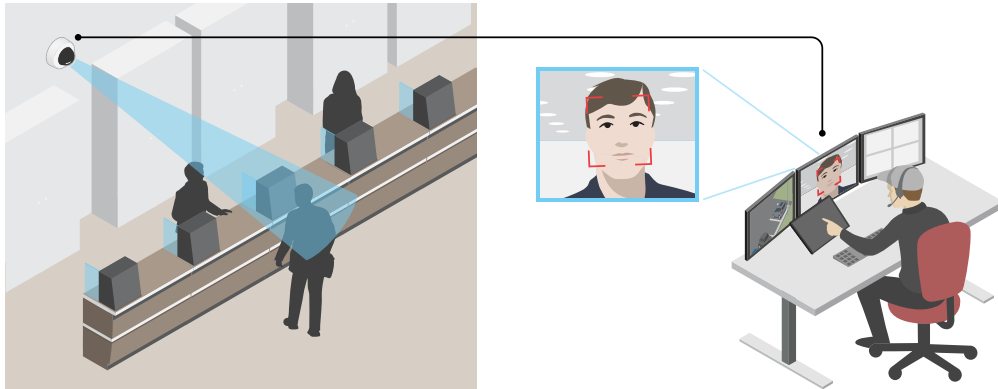

1. Go to **Settings > System > Orientation**.

2. Click  .

3. In the camera's live view, adjust the size and position of the rectangle around the area of interest, for example where you expect faces to appear.

You can see the number of pixels for each of the rectangle's sides (X and Y), and decide if the values are enough for your needs.

### Hide parts of the image with privacy masks

You can create one or several privacy masks to hide parts of the image.



*How to create a privacy mask*

1. Go to **Settings > Privacy mask**.
2. Click **New**.
3. Adjust the size, color, and name of the privacy mask according to your needs.

# AXIS M5000-G PTZ Camera

## Configure your device

---



To watch this video, go to the web version of this document.  
[help.axis.com/?&pid=70613&section=hide-parts-of-the-image-with-privacy-masks](https://help.axis.com/?&pid=70613&section=hide-parts-of-the-image-with-privacy-masks)

*How to change the appearance of the mask*

### Show the pan or tilt position as a text overlay

You can show the pan or tilt position as an overlay in the image.

1. Go to **Settings > Overlay** and click **Create overlay**.
2. Select **Text** and click **Create**.
3. In the text field, type #x to show the pan position.  
Type #y to show the tilt position.
4. Choose appearance, text size, and alignment.
5. The current pan and tilt positions show up in the live view image and in the recording.

### Adjust the camera view (PTZ)

To learn more about different pan, tilt, and zoom settings, see *Pan, tilt, and zoom (PTZ)* on page 20.

### Limit the pan, tilt, and zoom movements

If there are parts of the scene that you don't want the camera to reach, you can limit the pan, tilt, and zoom movements. For example, you want to protect the privacy of residents in an apartment building, which is located close to a parking lot that you intend to monitor. To limit the movements, go to **Settings > PTZ > Limits**.

### Create a guard tour with preset positions

A guard tour displays the video stream from different preset positions either in a predetermined or random order, and for configurable periods of time.

1. Go to **Settings > PTZ > Guard tours**.
2. Click **+**.
3. To edit the guard tour's properties, click **⚙**.
4. Type a name for the guard tour and specify the pause length in minutes between each tour.
5. If you want the guard tour to go to the preset positions in a random order, turn on **Shuffle**.
6. Click **Done**.
7. Click **Add** to add the preset positions that you want in your guard tour.
8. Click **Done** to exit the guard tour settings.
9. To schedule the guard tour, go to **System > Events**.

# AXIS M5000-G PTZ Camera

## Configure your device

---



To watch this video, go to the web version of this document.

[help.axis.com/?&pid=70613&section=create-a-guard-tour-with-preset-positions](http://help.axis.com/?&pid=70613&section=create-a-guard-tour-with-preset-positions)

### View and record video

This section includes instructions about configuring your device. To learn more about how streaming and storage works, go to *Streaming and storage on page 24*.

### Reduce bandwidth and storage

#### Important

If you reduce the bandwidth it can result in loss of details in the picture.

1. Go to live view and select H.264.
2. Go to **Settings > Stream**.
3. Do one or more of the following:
  - Turn on the Zipstream functionality and select the desired level.
  - Turn on dynamic GOP and set a high GOP length value.
  - Increase the compression.
  - Turn on dynamic FPS.

### Set up network storage

To store recordings on the network, you need to set up your network storage.

1. Go to **Settings > System > Storage**.
2. Click **Setup** under **Network storage**.
3. Enter the IP address of the host server.
4. Enter the name of the shared location on the host server.
5. Move the switch if the share requires a login, and enter username and password.
6. Click **Connect**.

### Record and watch video

To record video you must first set up network storage, see *Set up network storage on page 12*, or have an SD card installed.

#### Record video

1. Go to the live view.
2. To start a recording, click **Record**. Click again to stop the recording.

#### Watch video

# AXIS M5000-G PTZ Camera

## Configure your device

---

1. Click **Storage > Go to recordings**.
2. Select your recording in the list and it will play automatically.

### Set up rules for events

You can create rules to make your device perform an action when certain events occur. A rule consists of conditions and actions. The conditions can be used to trigger the actions. For example, the device can start a recording or send an email when it detects motion, or show an overlay text while the device is recording.

To learn more, check out our guide *Get started with rules for events*.

### Trigger an action

1. Go to **Settings > System > Events** to set up a rule. The rule defines when the device will perform certain actions. Rules can be setup as scheduled, recurring, or for example, triggered by motion detection.
2. Select the **Condition** that must be met to trigger the action. If you specify more than one condition for the rule, all of the conditions must be met to trigger the action.
3. Select which **Action** the device should perform when the conditions are met.

#### Note

If you make changes to an active rule, you have to restart the rule for the changes to take effect.

#### Note

If you change the definition of a stream profile that is used in a rule, you have to restart all the rules that use that stream profile.

### Record video when the camera detects motion

This example explains how to set up the camera to start recording to the SD card five seconds before it detects motion and to stop one minute after.



To watch this video, go to the web version of this document.

[help.axis.com/?&pid=70613&section=record-video-when-the-camera-detects-motion](http://help.axis.com/?&pid=70613&section=record-video-when-the-camera-detects-motion)

*How to record a video stream when the camera detects motion*

Make sure that AXIS Video Motion Detection is running:

1. Go to **Settings > Apps > AXIS Video Motion Detection**.
2. Start the application if it is not already running.
3. Make sure you have set up the application according to your needs. If you need help, see the *user manual for AXIS Video Motion Detection 4*.

Create a rule:

# AXIS M5000-G PTZ Camera

## Configure your device

---

1. Go to **Settings > System > Events** and add a rule.
2. Type a name for the rule.
3. In the list of conditions, under **Application**, select **AXIS Video Motion Detection (VMD)**.
4. In the list of actions, under **Recordings**, select **Record video while the rule is active**.
5. Select an existing stream profile or create a new one.
6. Set the prebuffer time to 5 seconds.
7. Set the postbuffer time to 60 seconds.
8. In the list of storage options, select **SD card**.
9. Click **Save**.

### Show a text overlay in the video stream when the device detects motion

This example explains how to display the text "Motion detected" when the device detects motion.



*How to show text overlay when the camera detects motion*

Make sure that **AXIS Video Motion Detection** is running:

1. Go to **Settings > Apps > AXIS Video Motion Detection**.
2. Start the application if it is not already running.
3. Make sure you have set up the application according to your needs.

Add the overlay text:

4. Go to **Settings > Overlay**.
5. Enter #D in the text field.
6. Choose text size and appearance.

Create a rule:

7. Go to **System > Events > Rules** and add a rule.
8. Type a name for the rule.
9. In the list of conditions, select **AXIS Video Motion Detection**.
10. In the list of actions, select **Use overlay text**.

# AXIS M5000-G PTZ Camera

## Configure your device

---

11. Select Camera 1.
12. Type "Motion detected".
13. Set the duration.
14. Click **Save**.

### Direct the camera to a preset position when the wireless PIR motion sensor detects motion

#### Note

There may be up to 2 s delay from when the motion is detected to when the camera triggers the rule. Consider this latency when deciding the best placement of the products.

Add a preset position:

1. Go to **Settings > PTZ** and set where you want the camera to be directed by creating a preset position.

Create a rule for the PIR sensor:

2. Go to **Settings > System > Events > Rules** and add a rule.
3. Type a name for the rule.
4. In the list of conditions, select **Z-Wave input**.
5. Select **<device name> - Motion Detected**.
6. In the list of actions, select **Go to preset position**.
7. Select a video channel and the preset position you want the camera to go to.
8. If you want the camera to return to its home position when the rule is no longer active, select **Home timeout**.
9. Click **Save**.

To record video, add an additional rule:

10. Go to **Settings > System > Events > Rules** and add a rule.
11. Type a name for the rule.
12. In the list of conditions, select **PTZ preset position reached**.
13. In the list of actions, select **Record video**.
14. Select an existing stream profile or create a new one.
15. Set the prebuffer to 5 seconds.
16. Set the postbuffer to 60 seconds.
17. Select **SD card** from the list of storage options.
18. Click **Save**.

### Use audio to deter intruders

This example explains how to connect a speaker to the camera and set it up to play a warning message when the camera detects motion in a restricted area.

Required hardware:

- Active speaker with built-in amplifier and connecting wires

# AXIS M5000-G PTZ Camera

## Configure your device

---

### **NOTICE**

Make sure the camera is disconnected from power before making the connections. Reconnect to power after connecting the wires.

Physical connection:

1. Connect the audio wire to the speaker from the line out pin of the audio connector.
2. Connect the grounding wire to the speaker from the GND pin of the audio connector.

Add audio clip to the camera:

1. Go to **Settings > Audio > Output** and click  .
2. Click **Upload new clip**.
3. Browse to locate your audio clip and click **Done**.

Create a rule:



1. Open the device webpage for the camera.
2. Go to **Settings > System > Events**.
3. Go to **Recipients** and add a recipient.
  - 3.1 Go to the device webpage of the speaker that has the audio clip stored on its SD card.
  - 3.2 Copy a link to the audio clip.
  - 3.3 Return to the device webpage of the camera.
4. Go to **Rules** and add a new rule:
  - 4.1 Under **Condition**, select **Video motion detection**.
  - 4.2 Under **Action**, select **Send notification through HTTP**.

### **Record video when the camera detects impact**

Shock detection allows the camera to detect tampering caused by vibrations or shock. Vibrations due to the environment or to an object can trigger an action depending on the shock sensitivity range, which can be set from 0 to 100. In this scenario, someone is throwing rocks at the camera after hours and you would like to get a video clip of the event.

Turn on shock detection:

1. Go to **Settings > System > Detectors**.



# AXIS M5000-G PTZ Camera

## Configure your device

---

2. Turn on shock detection, and set a value for the shock sensitivity.

Create a rule:

1. Go to **Settings > System > Events** and add a rule.
2. Type a name for the rule.
3. In the list of conditions, under **Device status**, select **Shock detected**.
4. Click **+** to add a second condition.
5. In the list of conditions, under **Scheduled and recurring**, select **Scheduled event**.
6. In the list of schedules, select **After hours**.
7. In the list of actions, under **Recordings**, select **Record video while the rule is active**.
8. Select a **Camera**.
9. Set the prebuffer time to 5 seconds.
10. Set the postbuffer time to 60 seconds.
11. Select where to save the recordings.
12. Click **Save**.

## Audio

### Add audio to your recording

Turn on audio:

1. Go to **Settings > Audio** and turn on **Allow audio**.
2. Go to **Input > Type** and select your audio source.

Edit the stream profile which is used for the recording:

3. Go to **Settings > Stream** and click **Stream profiles**.
4. Select the stream profile and click **Audio**.
5. Select the checkbox and select **Include**.
6. Click **Save**.
7. Click **Close**.

# AXIS M5000-G PTZ Camera

## Cleaning recommendations

---

### Cleaning recommendations

**NOTICE**

Never use harsh detergent, for example gasoline, benzene, or acetone.

1. Use a can of compressed air to remove any dust or loose dirt from the device.
2. If necessary, clean the lens with a soft cloth dampened with lukewarm water.

**Note**

Avoid cleaning in direct sunlight or at elevated temperatures, as this may cause stains when the water droplets dry.

# AXIS M5000-G PTZ Camera

Learn more

---

Learn more

## Capture modes

A capture mode is a preset configuration that defines how the camera captures images. The capture mode setting can affect the camera's field of view and aspect ratio. The shutter speed can also be affected, which in turn affects the light sensitivity.

The lower resolution capture mode might be sampled from the original resolution, or it might be cropped out from the original, in which case the field of view could also be affected.

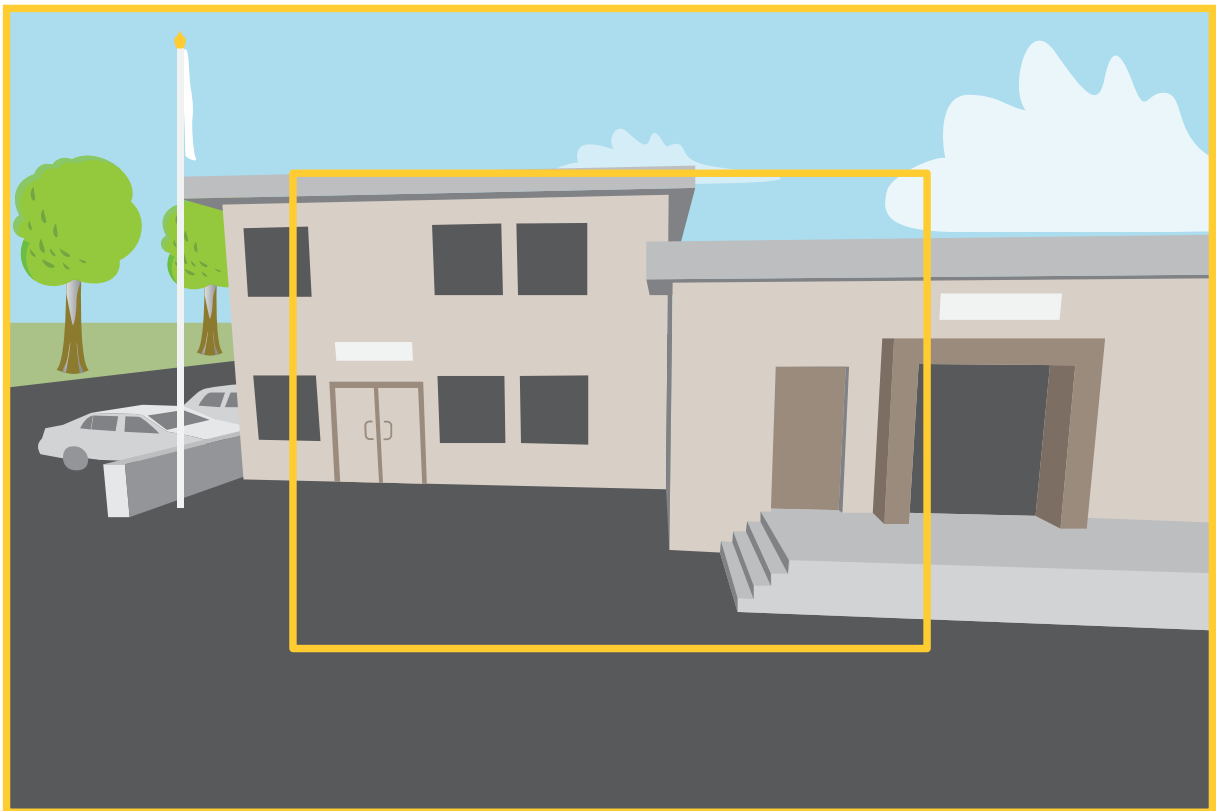

*The image shows how the field of view and aspect ratio can change between two different capture modes.*

What capture mode to choose depends on the requirements for the frame rate and resolution of the specific surveillance setup. For specifications about available capture modes, see the product's datasheet at [axis.com](https://www.axis.com).

## Privacy masks

A privacy mask is a user-defined area that prevents users from viewing a part of the monitored area. In the video stream, privacy masks appear as blocks of solid color.

The privacy mask is relative to the pan, tilt, and zoom coordinates, so regardless of where you point the camera, the privacy mask covers the same place or object.

You'll see the privacy mask on all snapshots, recorded video, and live streams.

You can use the VAPIX® application programming interface (API) to hide the privacy masks.

# AXIS M5000-G PTZ Camera

## Learn more

---

### Important

If you use multiple privacy masks it may affect the product's performance.

You can create several privacy masks. The maximum number of masks depends on the complexity of all the masks combined. The more anchor points in each mask, the fewer masks you can create. Each mask can have 3 to 10 anchor points.

## Overlays

Overlays are superimposed over the video stream. They are used to provide extra information during recordings, such as a timestamp, or during product installation and configuration. You can add either text or an image.

## Pan, tilt, and zoom (PTZ)

### Guard tours

A guard tour displays the video stream from different preset positions either in a predetermined or random order, and for configurable periods of time. Once started, a guard tour continues to run until stopped, even when there are no clients (web browsers) viewing the images.

## Wireless I/O (Z-Wave Plus™ v2)

This is a security enabled Z-Wave Plus™ v2 product that can use encrypted Z-Wave Plus v2 messages to communicate with security enabled Z-Wave Plus v2 devices. The product can be operated in any Z-Wave™ network with compatible Z-Wave certified devices from other manufacturers. To increase the network reliability, all non-battery operated Z-Wave devices in the network act as repeaters regardless of vendor. This product acts as the control device and the Z-Wave devices added to it act as secondary devices.

## Considerations

Before using wireless I/O with Z-Wave Plus v2, consider the following:

- To see the Z-Wave configurations, you need to use the device's legacy interface.
- To do any Z-Wave configurations, you need to be an administrator.
- When performing Z-Wave related actions on the product's web page, such as adding, removing and replacing Z-Wave devices or resetting the Z-Wave network, we recommend that you do not reload the page or move away from it when the action process is ongoing. If done, the action's actual and displayed statuses may differ. To recover, you may need to wait up to several minutes and then reload the page again.
- Replication, i.e. copying network information to another control device, is executed as part of the inclusion process.
- This product ignores all commands in the Basic Command Class.
- If the network primary controller is missing or otherwise inoperable, you need to reset to factory default settings from the product's web page. To do this, go to **Settings > System > Maintenance > Reset**, and click **Default**.

## Associations

- This product supports one association group with group identifier = 1 (LifeLine).
- Maximum number of devices that can be added to the association group = 1.
- Group identifier 1 is used to send the Device Reset Locally report.

## Command classes

This product supports the following command classes:

# AXIS M5000-G PTZ Camera

## Learn more

---

- COMMAND\_CLASS\_APPLICATION\_STATUS
- COMMAND\_CLASS\_ASSOCIATION\_V3 (secured)
- COMMAND\_CLASS\_ASSOCIATION\_GRP\_INFO\_V3 (secured)
- COMMAND\_CLASS\_CRC\_16\_ENCAP
- COMMAND\_CLASS\_DEVICE\_RESET\_LOCALLY (secured)
- COMMAND\_CLASS\_FIRMWARE\_UPDATE\_MD\_V5 (secured)
- COMMAND\_CLASS\_INCLUSION\_CONTROLLER
- COMMAND\_CLASS\_INDICATOR\_V3 (secured)
- COMMAND\_CLASS\_MANUFACTURER\_SPECIFIC\_V2 (secured)
- COMMAND\_CLASS\_MULTI\_CHANNEL\_ASSOCIATION\_V4 (secured)
- COMMAND\_CLASS\_MULTI\_CMD
- COMMAND\_CLASS\_NETWORK\_MANAGEMENT\_BASIC\_V2 (secured)
- COMMAND\_CLASS\_NETWORK\_MANAGEMENT\_INCLUSION\_V4 (secured)
- COMMAND\_CLASS\_NETWORK\_MANAGEMENT\_INSTALLATION\_MAINTENANCE\_V4 (secured)
- COMMAND\_CLASS\_NETWORK\_MANAGEMENT\_PROXY\_V4 (secured)
- COMMAND\_CLASS\_NODE\_PROVISIONING (secured)
- COMMAND\_CLASS\_POWERLEVEL (secured)
- COMMAND\_CLASS\_SECURITY
- COMMAND\_CLASS\_SECURITY\_2
- COMMAND\_CLASS\_SUPERVISION
- COMMAND\_CLASS\_TIME
- COMMAND\_CLASS\_TRANSPORT\_SERVICE\_V2
- COMMAND\_CLASS\_VERSION\_V3 (secured)
- COMMAND\_CLASS\_ZWAVEPLUS\_INFO\_V2 (secured)

### Note

The product supports COMMAND\_CLASS\_INDICATOR\_V3, however there is no visible indicator.

### Turn on Z-Wave

1. Go to **Settings > System > Z-Wave**.
2. Go to **Gateway settings wireless I/O** and turn on Z-Wave. You may need to wait for a few minutes for Z-Wave to become active.

### Add a Z-Wave device

Though not limited by the Z-Wave Plus v2 protocol, your product's event system allows you to add Z-Wave devices at any given time. If the maximum number is reached, you need to remove a Z-Wave device before you can add a new one. See the product's datasheet for information about maximum number of Z-Wave devices.

1. Go to **Settings > System > Z-Wave**.

# AXIS M5000-G PTZ Camera

## Learn more

---

2. Go to **Device management** and click **+** . The product starts looking for Z-Wave devices in the Z-Wave network.
3. Set the Z-Wave device to be added into inclusion/exclusion mode as described in its User Manual.
4. If requested, enter the PIN delivered with the Z-Wave device, and click **OK**.
5. Wait until the adding process is finalized as indicated by a notification on the web page.

The added Z-Wave device is now visible in the device management list.

### Note

If the Z-Wave device is not found, the adding process is terminated automatically.

To see the detailed status information of the added Z-Wave device, expand the device information in the device management list.

### Note

Status information for an added Z-Wave device varies depending on the device type. For more information, see the online help  .

You can set the product to trigger rules with specified Z-Wave trigger conditions. The available Z-Wave conditions and actions vary depending on the added Z-Wave device type.

## Add a Z-Wave device with SmartStart inclusion

You can add a Z-Wave device to the Z-Wave network with SmartStart inclusion. A Z-Wave device added to the SmartStart list is automatically added to the device management list within 10 minutes of being powered on in the network vicinity.

1. Go to **Settings > System > Z-Wave**.
2. Go to **SmartStart** and click **+** .
3. Type the device specific key and any optional information.
4. Click **OK**.

## Remove a Z-Wave device through inclusion/exclusion mode

### Note

This is the recommended removal procedure.

1. Go to **Settings > System > Z-Wave**.
2. Go to **Device management** and click  . The product starts looking for Z-Wave devices in the Z-Wave network.
3. Set the Z-Wave device to be removed into inclusion/exclusion mode as described in its User Manual.
4. Wait until the removal process is finalized as indicated by a notification on the web page.

The Z-Wave device is now removed from the device management list.

### Note

All product-related information in the removed Z-Wave device is deleted.

### Note

If the Z-Wave device is not found, the removal process is terminated automatically.

# AXIS M5000-G PTZ Camera

## Learn more

---

### Remove a Z-Wave device through forced process

There may be a communication fail, for example due to drained battery, so you may not be able to remove the Z-Wave device by setting it to inclusion/exclusion mode. You can perform a forced removal of a Z-Wave device that shows status **Down** in the device management list.

1. Go to **Settings > System > Z-Wave**.
2. Go to **Device management** and expand the device information for the Z-Wave device to be removed.
3. Go to **Node > Status** and click .
4. Wait until the exclusion process is finalized as indicated by a notification on the web page.

The Z-Wave device is now removed from the device management list.

#### Note

All product-related information in the removed Z-Wave device is retained.

### Remove a Z-Wave device from the SmartStart list

#### Note

A Z-Wave device will not be removed from the device management list if you remove it from the SmartStart list.

1. Go to **Settings > System > Z-Wave**.
2. Go to **SmartStart**.
3. Click  next to the Z-Wave device to be removed from the SmartStart list.

### Replace a Z-Wave device

There may be a communication fail, for example due to a faulty Z-Wave device, and you want to replace the device with another one. You can perform a forced replacement of a Z-Wave device that shows status **Down** in the device management list.

1. Go to **Settings > System > Z-Wave**.
2. Go to **Device management** and expand the device information for the Z-Wave device to be replaced.
3. Go to **Node > Status** and click . The product starts looking for Z-Wave devices in the Z-Wave network.
4. Set the Z-Wave device that is to replace the existing device into inclusion/exclusion mode as described in its User Manual.
5. Wait until the replacement process is finalized as indicated by a notification on the web page.

The new Z-Wave device with some status information is now visible in the device management list.

#### Note

Node ID and event action information is handed over to the new Z-Wave device. All other information is deleted.

#### Note

If the Z-Wave device is not found, the replacement process is terminated automatically.

# AXIS M5000-G PTZ Camera

## Learn more

---

### Reset the Z-Wave network

#### Important

- This procedure removes all Z-Wave devices from the product.
- After resetting the Z-Wave network, you also need to either remove each Z-Wave device or reset it to factory default before you can add it to any network again.
- Use this procedure only when the network primary controller is missing or otherwise inoperable.

1. Go to **Settings > System > Z-Wave**.

2. Go to **Device management** and click  .

3. Click **OK** to confirm the reset.

All added Z-Wave devices are now removed from the product, and the device management list is empty.

### Use Z-Wave as I/O

This product doesn't have any physical I/O connectors, but you can use Z-Wave functions in the I/O interface.

You can assign an I/O port number to up to a maximum of six connected Z-Wave devices. To see the port numbers, go to **Settings > System > I/O ports**. The I/O port number can be changed in the Z-Wave device's information window.

When used as a digital input port event, the Z-Wave device can only use one function. The default function depends on what type of device it is. To change which function to use, go to the device's information window.

For more information about using I/O ports, see the product's built-in help.

## Streaming and storage

### Video compression formats

Decide which compression method to use based on your viewing requirements, and on the properties of your network. The available options are:

#### Motion JPEG

Motion JPEG, or MJPEG, is a digital video sequence that is made up of a series of individual JPEG images. These images are then displayed and updated at a rate sufficient to create a stream that shows constantly updated motion. For the viewer to perceive motion video the rate must be at least 16 image frames per second. Full motion video is perceived at 30 (NTSC) or 25 (PAL) frames per second.

The Motion JPEG stream uses considerable amounts of bandwidth, but provides excellent image quality and access to every image contained in the stream.

#### H.264 or MPEG-4 Part 10/AVC

#### Note

H.264 is a licensed technology. The Axis product includes one H.264 viewing client license. To install additional unlicensed copies of the client is prohibited. To purchase additional licenses, contact your Axis reseller.

H.264 can, without compromising image quality, reduce the size of a digital video file by more than 80% compared to the Motion JPEG format and by as much as 50% compared to older MPEG formats. This means that less network bandwidth and storage space are required for a video file. Or seen another way, higher video quality can be achieved for a given bitrate.

### How do Image, Stream, and Stream profile settings relate to each other?

The **Image** tab contains camera settings that affect all video streams from the product. If you change something in this tab, it immediately affects all video streams and recordings.



# AXIS M5000-G PTZ Camera

## Learn more

---

The **Stream** tab contains settings for video streams. You get these settings if you request a video stream from the product and don't specify for example resolution, or frame rate. When you change the settings in the **Stream** tab, it doesn't affect ongoing streams, but it will take effect when you start a new stream.

The **Stream profiles** settings override the settings from the **Stream** tab. If you request a stream with a specific stream profile, the stream contains the settings of that profile. If you request a stream without specifying a stream profile, or request a stream profile that doesn't exist in the product, the stream contains the settings from the **Stream** tab.

### Bitrate control

Bitrate control helps you to manage the bandwidth consumption of your video stream.

#### Variable bitrate (VBR)

Variable bitrate allows the bandwidth consumption to vary depending on the level of activity in the scene. The more activity, the more bandwidth you need. With variable bitrate you are guaranteed constant image quality, but you need to make sure you have storage margins.

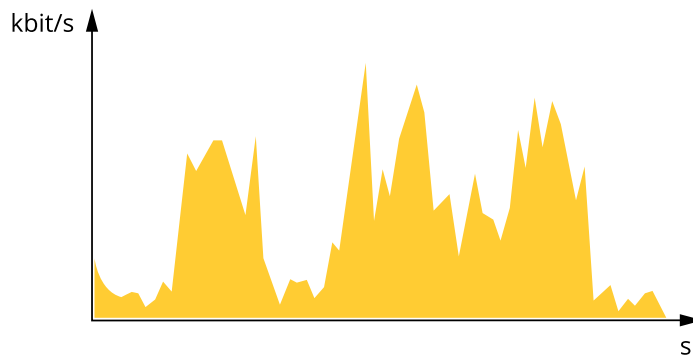

#### Maximum bitrate (MBR)

Maximum bitrate lets you set a target bitrate to handle bitrate limitations in your system. You might see a decline in image quality or frame rate as the instantaneous bitrate is kept below the specified target bitrate. You can choose to prioritize either image quality or frame rate. We recommend that you configure the target bitrate to a higher value than the expected bitrate. This gives you a margin in case there is a high level of activity in the scene.

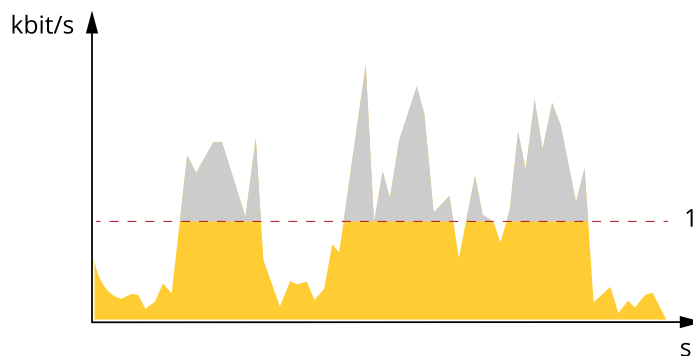

1 Target bitrate

#### Average bitrate (ABR)

With average bitrate, the bitrate is automatically adjusted over a longer period of time. This is so you can meet the specified target and provide the best video quality based on your available storage. Bitrate is higher in scenes with a lot of activity, compared to static scenes. You are more likely to get better image quality when in scenes with a lot of activity if you use the average bitrate option. You

# AXIS M5000-G PTZ Camera

## Learn more

---

can define the total storage required to store the video stream for a specified amount of time (retention time) when image quality is adjusted to meet the specified target bitrate. Specify the average bitrate settings in one of the following ways:

- To calculate the estimated storage need, set the target bitrate and the retention time.
- To calculate the average bitrate, based on available storage and required retention time, use the target bitrate calculator.

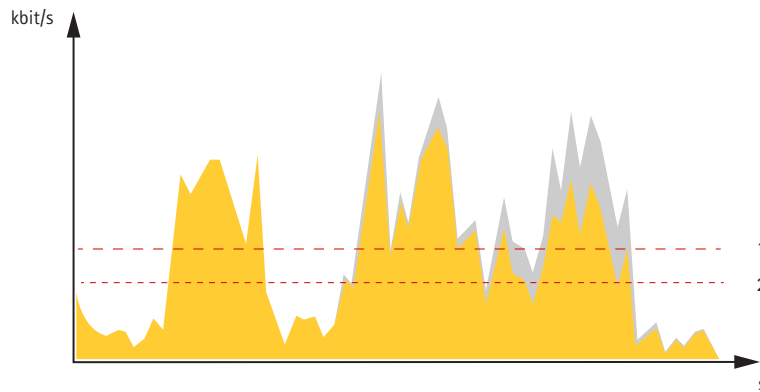

- 1 Target bitrate
- 2 Actual average bitrate

You can also turn on maximum bitrate and specify a target bitrate within the average bitrate option.

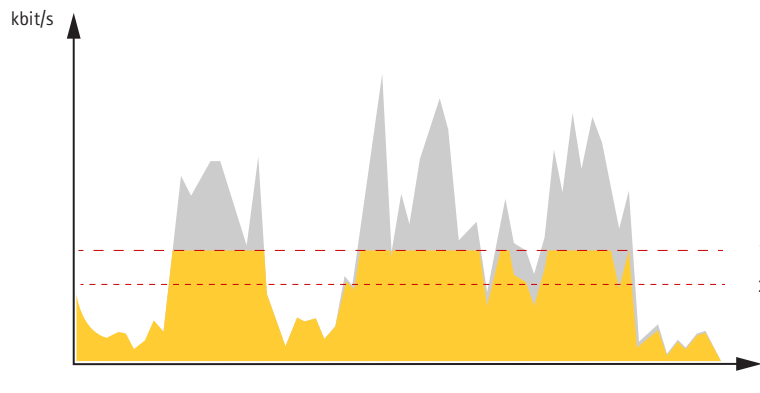

- 1 Target bitrate
- 2 Actual average bitrate

## Applications

AXIS Camera Application Platform (ACAP) is an open platform that enables third parties to develop analytics and other applications for Axis products. To find out more about available applications, downloads, trials and licenses, go to [axis.com/applications](https://axis.com/applications).

To find the user manuals for Axis applications, go to [help.axis.com](https://help.axis.com).

### Note

- Several applications can run at the same time but some applications might not be compatible with each other. Certain combinations of applications might require too much processing power or memory resources when run in parallel. Verify that the applications work together before deployment.

# AXIS M5000-G PTZ Camera

Learn more

---

**Important**

AXIS 3D People Counter is an application that is embedded in the device. We don't recommend you to run any other applications on this device since it can affect the performance of the AXIS 3D People Counter.



To watch this video, go to the web version of this document.

*[help.axis.com/?&tpiald=70613&tsection=about-applications](http://help.axis.com/?&tpiald=70613&tsection=about-applications)*

*How to download and install an application*



To watch this video, go to the web version of this document.

*[help.axis.com/?&tpiald=70613&tsection=about-applications](http://help.axis.com/?&tpiald=70613&tsection=about-applications)*

*How to activate an application licence code on a device*

# AXIS M5000-G PTZ Camera

## Troubleshooting

---

### Troubleshooting

#### Reset to factory default settings

##### Important

If you have a Z-Wave network, you must reset the Z-Wave network before resetting your device to factory default. See *Reset the Z-Wave network on page 24*.

##### Important

Reset to factory default should be used with caution. A reset to factory default resets all settings, including the IP address, to the factory default values.

##### Note

The camera has been preconfigured with AXIS License Plate Verifier. If you reset to factory default, you need to reinstall the license key. See .

To reset the product to the factory default settings:

1. Disconnect power from the product.
2. Press and hold the control button while reconnecting power. See *Product overview on page 32*.
3. Keep the control button pressed for 15–30 seconds until the status LED indicator flashes amber.
4. Release the control button. The process is complete when the status LED indicator turns green. The product has been reset to the factory default settings. If no DHCP server is available on the network, the default IP address is 192 . 168 . 0 . 90.
5. Use the installation and management software tools to assign an IP address, set the password, and access the device.

The installation and management software tools are available from the support pages on [axis.com/support](https://axis.com/support).

You can also reset parameters to factory default through the device's webpage. Go to **Maintenance > Factory default** and click **Default**.

#### Firmware options

Axis offers product firmware management according to either the active track or the long-term support (LTS) tracks. Being on the active track means continuously getting access to all the latest product features, while the LTS tracks provide a fixed platform with periodic releases focused mainly on bug fixes and security updates.

Using firmware from the active track is recommended if you want to access the newest features, or if you use Axis end-to-end system offerings. The LTS tracks are recommended if you use third-party integrations, which are not continuously validated against the latest active track. With LTS, the products can maintain cybersecurity without introducing any significant functional changes or affecting any existing integrations. For more detailed information about Axis product firmware strategy, go to [axis.com/support/firmware](https://axis.com/support/firmware).

#### Check the current firmware version

Firmware is the software that determines the functionality of network devices. When you troubleshoot a problem, we recommend you to start by checking the current firmware version. The latest firmware version might contain a correction that fixes your particular problem.

To check the current firmware:

1. Go to the device interface > **Status**.
2. See the firmware version under **Device info**.

# AXIS M5000-G PTZ Camera

## Troubleshooting

---

### Upgrade the firmware

#### Important

Preconfigured and customized settings are saved when you upgrade the firmware (provided that the features are available in the new firmware) although this is not guaranteed by Axis Communications AB.

#### Important

Make sure the device remains connected to the power source throughout the upgrade process.

#### Note

When you upgrade the device with the latest firmware in the active track, the product receives the latest functionality available. Always read the upgrade instructions and release notes available with each new release before you upgrade the firmware. To find the latest firmware and the release notes, go to [axis.com/support/firmware](http://axis.com/support/firmware).

1. Download the firmware file to your computer, available free of charge at [axis.com/support/firmware](http://axis.com/support/firmware).
2. Log in to the device as an administrator.
3. Go to **Maintenance > Firmware upgrade** and click **Upgrade**.

When the upgrade has finished, the product restarts automatically.

You can use AXIS Device Manager to upgrade multiple devices at the same time. Find out more at [axis.com/products/axis-device-manager](http://axis.com/products/axis-device-manager).

### Technical issues, clues, and solutions

If you can't find what you're looking for here, try the troubleshooting section at [axis.com/support](http://axis.com/support).

#### Problems upgrading the firmware

---

Firmware upgrade failure	If the firmware upgrade fails, the device reloads the previous firmware. The most common reason is that the wrong firmware file has been uploaded. Check that the name of the firmware file corresponds to your device and try again.
Problems after firmware upgrade	If you experience problems after a firmware upgrade, roll back to the previously installed version from the <b>Maintenance</b> page.

#### Problems setting the IP address

---

The device is located on a different subnet	If the IP address intended for the device and the IP address of the computer used to access the device are located on different subnets, you cannot set the IP address. Contact your network administrator to obtain an IP address.
The IP address is being used by another device	Disconnect the Axis device from the network. Run the ping command (in a Command/DOS window, type <code>ping</code> and the IP address of the device): <ul style="list-style-type: none"><li>• If you receive: <code>Reply from &lt;IP address&gt;: bytes=32; time=10...</code> this means that the IP address may already be in use by another device on the network. Obtain a new IP address from the network administrator and reinstall the device.</li><li>• If you receive: <code>Request timed out</code>, this means that the IP address is available for use with the Axis device. Check all cabling and reinstall the device.</li></ul>
Possible IP address conflict with another device on the same subnet	The static IP address in the Axis device is used before the DHCP server sets a dynamic address. This means that if the same default static IP address is also used by another device, there may be problems accessing the device.

# AXIS M5000-G PTZ Camera

## Troubleshooting

---

### The device can't be accessed from a browser

---

Can't log in	<p>When HTTPS is enabled, ensure that the correct protocol (HTTP or HTTPS) is used when attempting to log in. You may need to manually type <code>http</code> or <code>https</code> in the browser's address field.</p> <p>If the password for the user <code>root</code> is lost, the device must be reset to the factory default settings. See <i>Reset to factory default settings on page 28</i>.</p>
The IP address has been changed by DHCP	<p>IP addresses obtained from a DHCP server are dynamic and may change. If the IP address has been changed, use AXIS IP Utility or AXIS Device Manager to locate the device on the network. Identify the device using its model or serial number, or by the DNS name (if the name has been configured).</p> <p>If required, a static IP address can be assigned manually. For instructions, go to <a href="http://axis.com/support">axis.com/support</a>.</p>
Certificate error when using IEEE 802.1X	<p>For authentication to work properly, the date and time settings in the Axis device must be synchronized with an NTP server. Go to <b>System &gt; Date and time</b>.</p>

### The device is accessible locally but not externally

---

To access the device externally, we recommend you to use one of the following applications for Windows®:

- AXIS Companion: free of charge, ideal for small systems with basic surveillance needs.
- AXIS Camera Station: 30-day trial version free of charge, ideal for small to mid-size systems.

For instructions and download, go to [axis.com/vms](http://axis.com/vms).

### Problems with streaming

---

Multicast H.264 only accessible by local clients	<p>Check if your router supports multicasting, or if you need to configure the router settings between the client and the device. You might need to increase the TTL (Time To Live) value.</p>
No multicast H.264 displayed in the client	<p>Check with your network administrator that the multicast addresses used by the Axis device are valid for your network.</p> <p>Check with your network administrator to see if there is a firewall that prevents viewing.</p>
Poor rendering of H.264 images	<p>Ensure that your graphics card uses the latest driver. You can usually download the latest drivers from the manufacturer's website.</p>
Color saturation is different in H.264 and Motion JPEG	<p>Modify the settings for your graphics adapter. Go to the adapter's documentation for more information.</p>
Lower frame rate than expected	<ul style="list-style-type: none"><li>• See <i>Performance considerations on page 30</i>.</li><li>• Reduce the number of applications running on the client computer.</li><li>• Limit the number of simultaneous viewers.</li><li>• Check with the network administrator that there is enough bandwidth available.</li><li>• Lower the image resolution.</li><li>• Log in to the device's webpage and set a capture mode that prioritizes frame rate. If you change the capture mode to prioritize frame rate it might lower the maximum resolution, depending on the device used and capture modes available.</li></ul>

## Performance considerations

When setting up your system, it is important to consider how various settings and situations affect the performance. Some factors affect the amount of bandwidth (the bitrate) required, others can affect the frame rate, and some affect both. If the load on the CPU reaches its maximum, this also affects the frame rate.

The following factors are the most important to consider:

- High image resolution or lower compression levels result in images containing more data which in turn affects the bandwidth.
- Rotating the image in the GUI will increase the product's CPU load.

# AXIS M5000-G PTZ Camera

## Troubleshooting

---

- Access by large numbers of Motion JPEG or unicast H.264 clients affects the bandwidth.
- Simultaneous viewing of different streams (resolution, compression) by different clients affects both frame rate and bandwidth.  
  
Use identical streams wherever possible to maintain a high frame rate. Stream profiles can be used to ensure that streams are identical.
- Accessing Motion JPEG and H.264 video streams simultaneously affects both frame rate and bandwidth.
- Heavy usage of event settings affects the product's CPU load which in turn affects the frame rate.
- Using HTTPS may reduce frame rate, in particular if streaming Motion JPEG.
- Heavy network utilization due to poor infrastructure affects the bandwidth.
- Viewing on poorly performing client computers lowers perceived performance and affects frame rate.
- Running multiple AXIS Camera Application Platform (ACAP) applications simultaneously may affect the frame rate and the general performance.

### Contact support

Contact support at [axis.com/support](https://axis.com/support).

# AXIS M5000-G PTZ Camera

## Specifications

### Specifications

### Product overview

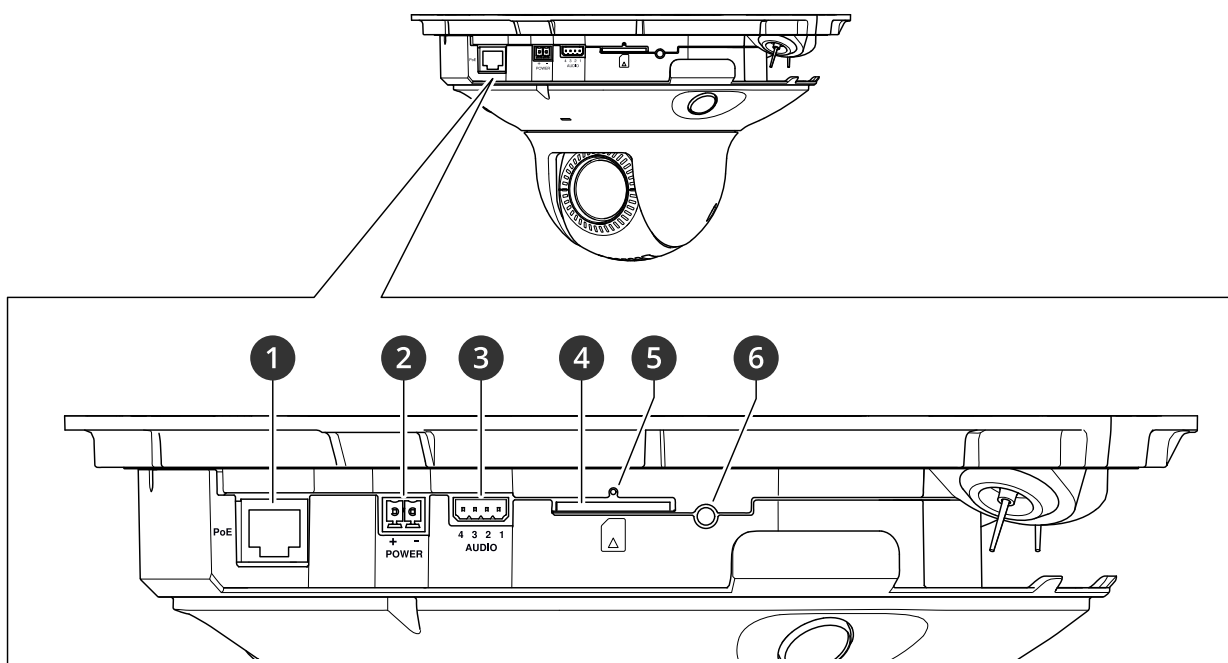

- 1 Network connector (PoE)
- 2 Power connector
- 3 Audio connector
- 4 SD card slot (SD/SDHC/SDXC card)
- 5 Status LED indicator
- 6 Control button

### How to remove the dome

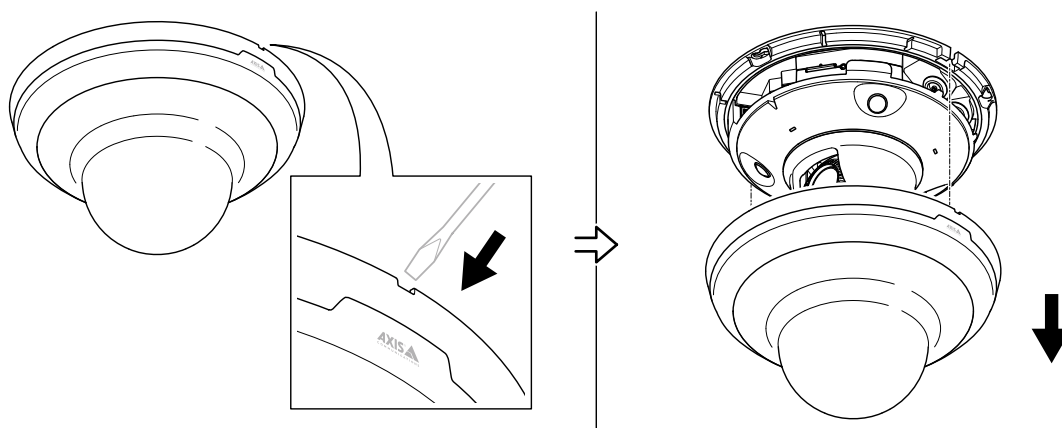



# AXIS M5000-G PTZ Camera

## Specifications

---

### LED indicators

Status LED	Indication
Unlit	Connection and normal operation.
Green	Shows steady green for 10 seconds for normal operation after startup completed.
Amber	Steady during startup. Flashes during firmware upgrade or reset to factory default.
Amber/Red	Flashes amber/red if network connection is unavailable or lost.

Wireless LED	Indication
Unlit	Wired mode.
Green	Steady for connection to a wireless network. Flashes for network activity.
Red	Steady for no wireless network connection. Flashes while scanning for wireless networks.
Amber	Steady or flashing during wireless network pairing.

### SD card slot

#### **NOTICE**

- Risk of damage to SD card. Do not use sharp tools, metal objects, or excessive force when inserting or removing the SD card. Use your fingers to insert and remove the card.
- Risk of data loss and corrupted recordings. Do not remove the SD card while the product is running. Unmount the SD card from the product's webpage before removal.

This product supports SD/SDHC/SDXC cards.

For SD card recommendations, see [axis.com](http://axis.com).



SD, SDHC, and SDXC Logos are trademarks of SD-3C LLC. SD, SDHC and SDXC are trademarks or registered trademarks of SD-3C, LLC in the United States, other countries or both.

### Buttons

#### Control button

The control button is used for:

- Resetting the product to factory default settings. See *Reset to factory default settings on page 28*.
- Connecting to a one-click cloud connection (O3C) service over the internet. To connect, press and hold the button for about 3 seconds until the status LED flashes green.

### Connectors

#### Network connector

RJ45 Ethernet connector with Power over Ethernet (PoE).

#### Audio connector

4-pin terminal block for audio input and output. See *Product overview on page 32*.

# AXIS M5000-G PTZ Camera

## Specifications

---

For audio in, the left channel is used from a stereo signal.

Pin	Notes
AUDIO IN	Microphone or line in (mono)
GND AUDIO IN	Ground audio in
AUDIO OUT	Line audio out
GND AUDIO OUT	Ground audio out

### Power connector

2-pin terminal block for DC power input. Use a Safety Extra Low Voltage (SELV) compliant limited power source (LPS) with either a rated output power limited to  $\leq 100$  W or a rated output current limited to  $\leq 5$  A.

