

ONU Integrated Service Router

User's Guide

Model: NSD-G3000T

Introduction

This document describes the AI Home Gateway (Model NSD-G3000T) overview and how to use Z-Wave™ functionality.

Feature Overview

The current product is a home gateway device. IoT devices such as sensors are connected and can be controlled with this device. This device supports various interfaces for the functionalities of Wireless LAN, Bluetooth, Z-Wave™.

The device can collect sensing data from various Z-Wave™ sensor devices, and uploading of the data to a cloud server by wired LAN communication is available.

The AI Home Gateway has the following general features:

- 4 LAN Ports
- Wireless LAN client
- Z-Wave™ communication
- Bluetooth communication

Names of Product Device Parts

The top and bottom view of the product device and parts names are as follows.

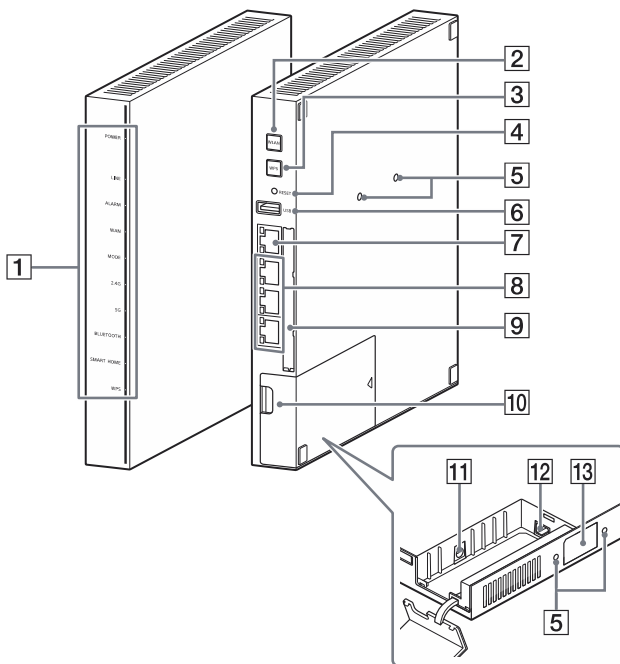

| No | Part Name |
|----|--------------------|
| 1 | System Status Lamp |
| 2 | WLAN Button |
| 3 | WPS Button |
| 4 | Reset Button |
| 5 | Mounting Hole |
| 6 | USB Port |
| 7 | WAN Port |
| 8 | LAN Ports |
| 9 | LAN Plate |
| 10 | Cover |
| 11 | DC-IN Jack |
| 12 | Optical Fiber Jack |
| 13 | SSID Label |

Installation

Installation of the AI Home Gateway is only a one step process:

1- Connect an AC adapter to the gateway and plug it into an AC outlet. The gateway has no power switch. It will begin operating as soon as it is plugged into the AC adapter/outlet.

The gateway needs to be connected to the internet via a WAN port.

LED Indication Information

System status LED/Lamp Indicator:

| LED Indicator/Lamp Type | Lamp Color and Status | Device Status |
|-------------------------|-----------------------|-------------------------------------|
| POWER | Green Steady State | Power is on |
| LINE | Green Blinking | Connecting G-PON |
| | Green Steady State | Connected G-PON |
| ALARM | Red Steady State | Optical fiber is disconnected |
| WAN | Green Steady State | Internet is connected via wired LAN |
| MODE | Green Steady State | G-PON mode |
| | Red Steady State | IPoE mode |
| 2.4G | Green Steady State | Wi-Fi(2.4GHz) is enabled |
| 5G | Green Steady State | Wi-Fi(5GHz) is enabled |
| BLUETOOTH | Green Steady State | Pairing with Bluetooth |
| WPS | Red Blinking | Pairing with WPS |
| | Red Steady State | Pairing was successful |

Z-Wave™ Overview

General Information

Device Type

Gateway

Role Type

Central Static Controller (CSC)

Command Class

Support

COMMAND_CLASS_APPLICATION_STATUS
COMMAND_CLASS_ASSOCIATION_V2
COMMAND_CLASS_ASSOCIATION_GRP_INFO
COMMAND_CLASS_CRC_16_ENCAP
COMMAND_CLASS_DEVICE_RESET_LOCALLY
COMMAND_CLASS_MANUFACTURER_SPECIFIC_V2
COMMAND_CLASS_POWERLEVEL
COMMAND_CLASS_SECURITY
COMMAND_CLASS_SECURITY_2
COMMAND_CLASS_VERSION_V2
COMMAND_CLASS_ZWAVEPLUS_INFO_V2

Control

COMMAND_CLASS_ASSOCIATION_V2
COMMAND_CLASS_BASIC
COMMAND_CLASS_CRC_16_ENCAP
COMMAND_CLASS_MULTI_CHANNEL_V4
COMMAND_CLASS_MULTI_CHANNEL_ASSOCIATION_V3
COMMAND_CLASS_WAKE_UP_V2
COMMAND_CLASS_BATTERY
COMMAND_CLASS_CONFIGURATION
COMMAND_CLASS_DOOR_LOCK_V2
COMMAND_CLASS_INDICATOR
COMMAND_CLASS_MANUFACTURER_SPECIFIC_V2
COMMAND_CLASS_METER_V3
COMMAND_CLASS_NODE_NAMING
COMMAND_CLASS_NOTIFICATION_V8
COMMAND_CLASS_SENSOR_MULTILEVEL_V11

Securely S2 Supported Command Class

COMMAND_CLASS_ASSOCIATION_GRP_INFO

COMMAND_CLASS_ASSOCIATION_V2

COMMAND_CLASS_MANUFACTURER_SPECIFIC_V2

COMMAND_CLASS_VERSION_V2

Interoperability

Any products from different manufacturers and product categories can be a part of the same Z-Wave™ network using the gateway, and different non-battery powered nodes can act as repeaters regardless of the manufacture.

Security Enabled Z-Wave Plus™ Product

The gateway is a security enabled Z-Wave Plus™ product.

Basic Command Class Handling

The gateway will ignore Basic Commands received from other devices in the Z-Wave™ network.

Support for Association Command Class

Group id: 1 – Lifeline

Maximum number of devices that can be added to the group: 5

All devices are associated with the group.

Android Controller Application “AI Home Gateway Controller”

Gateway Select Screen

When an available device is detected that can be used, the icon of the gateway is displayed.

If nothing is displayed, please confirm that the network is correctly set.

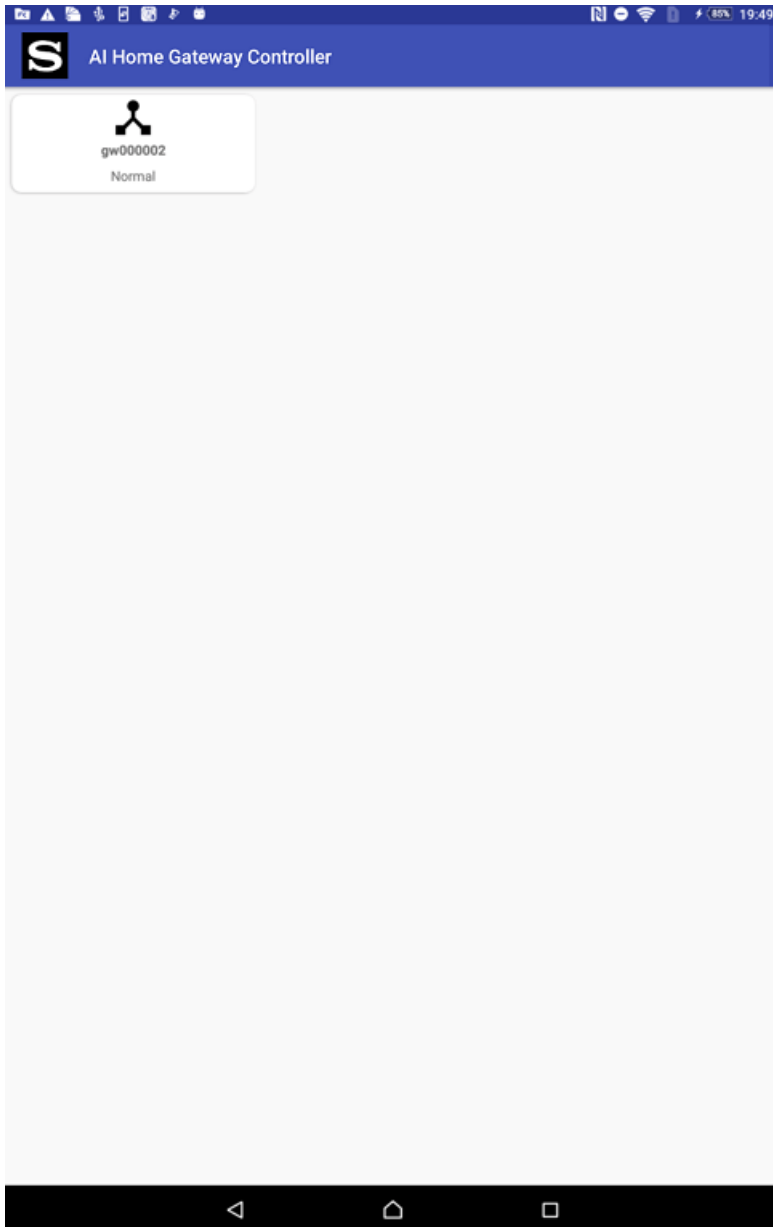

Device Viewer

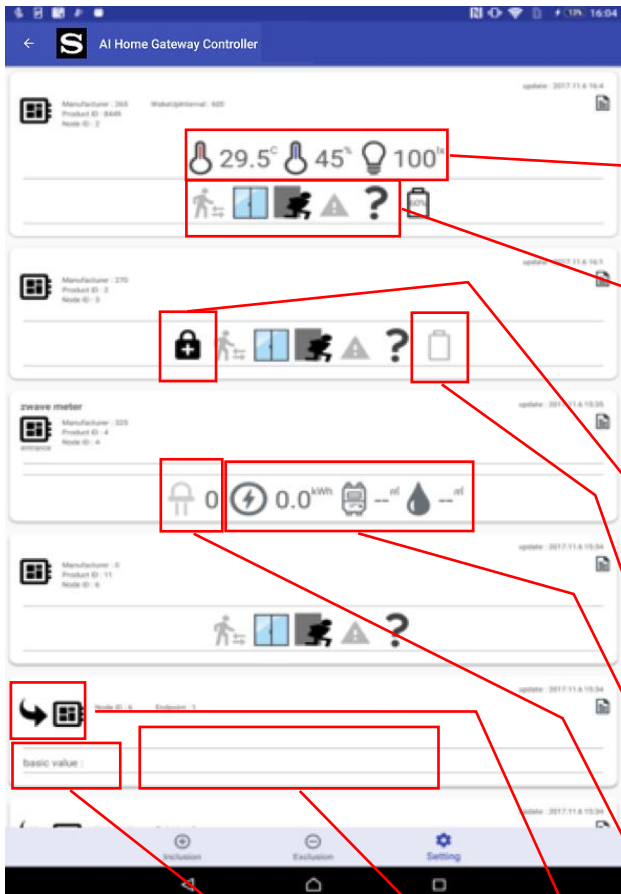

When a gateway is selected, available devices will be displayed. If there are no available devices, nothing will be displayed.

In the case of a device that supports temperature, humidity or illuminance, a report value is displayed.

These icons represent the state of Home Security. Whichever icon that appears shows the current event according to a notification received from the device.

If a device supports the lock / unlock function, the Lock Status is displayed.

The remaining battery power is displayed.

The values of various meters are displayed.

In order from the left: power meter, gas meter, and water meter.

The value of the indicator is displayed.

If a device has end points, all end points are displayed.

When an unsupported device is detected, no icon will be displayed in this area.

The report value of the latest Basic Command is displayed. *Only for unsupported devices.

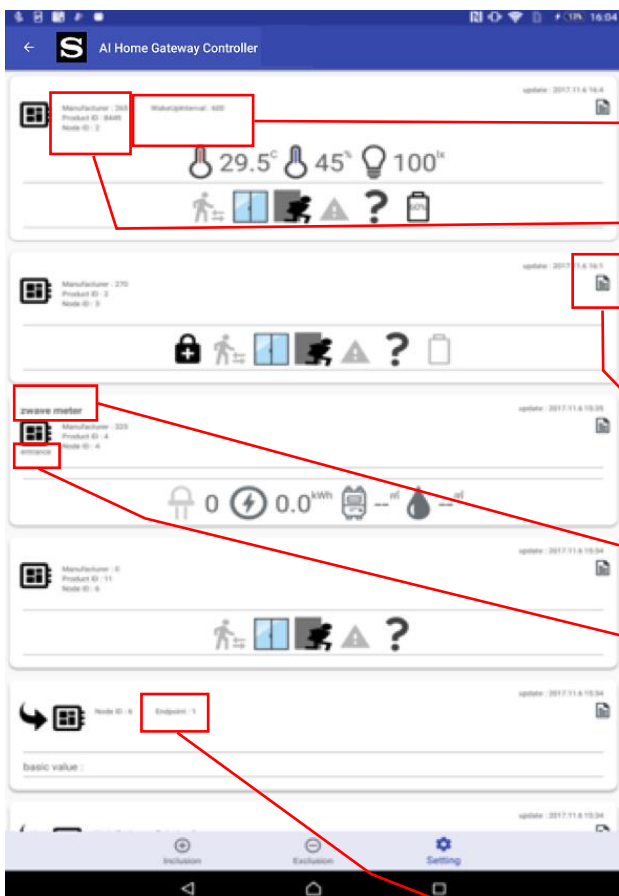

WakeupInterval: The value of the Wakeup Interval is displayed.

Manufacturer: The Manufacture ID is displayed.

Product ID: The Product ID is displayed.

Node ID: The Node ID is displayed.

By tapping the Report icon, a dialog of Association, Association Group Info, and Configuration is displayed.

Node Name

Node Location

Endpoint number is displayed.

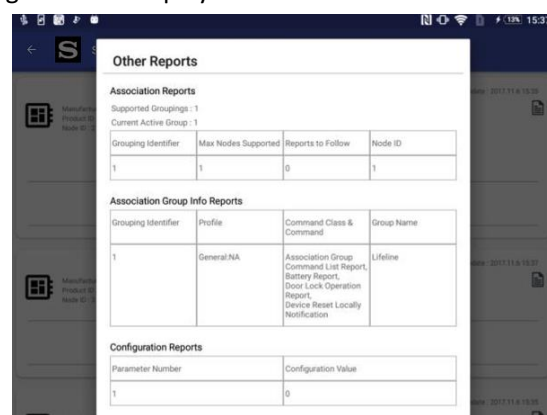



Device button

means one device



Device End point button

means End point

Lock status



lock



unlock

Multilevel sensor



means humidity



means temperature



means illuminance

Home security

Motion Detection



Undetected



Detected

Glass Breakage



Undetected



Detected

Intrusion



Undetected



Detected

Tampering



Undetected



Detected

Unknown



Undetected



Detected

Battery

Battery level is displayed



100%



Battery level is displayed as numerical value.



It is displayed when the battery level is low.



It is displayed when the battery level is not acquired.

Report button



When the report has been updated,
It is displayed with a red icon.



Indicator



The numerical value is displayed
on the right of the icon.

Meter



The value of the power meter is
displayed on the right of the icon.



The value of the gas meter is
displayed on the right of the icon.



The value of the water meter is
displayed on the right of the icon.

Inclusion (Add)



Inclusion (Adding devices)

To add a device to the Z-Wave™ network, press the “Inclusion” button in the Android Controller Application. This will put the gateway into Inclusion Mode. Then a gateway operation dialog will appear in the Android Controller Application. The gateway operation dialog will be displayed during the Inclusion Mode.

To stop the Inclusion Mode, press the “Abort” button in the gateway operation dialog, or wait for one minute and the Inclusion Mode will automatically stop. When the Inclusion Mode has stopped, the gateway operation dialog will automatically disappear.

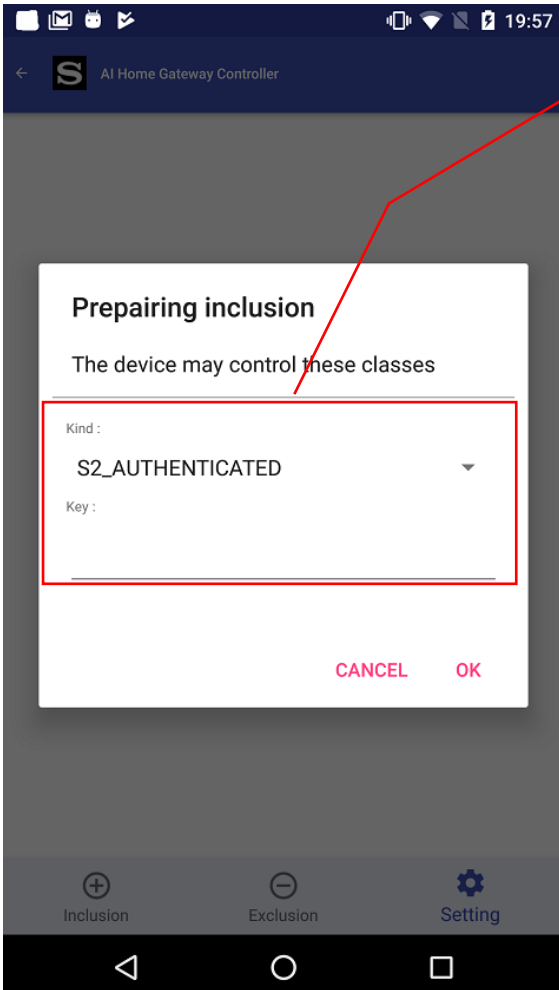

Select the item you want to set.

- S0
- S2_ACCESS
- S2_AUTHENTICATED
- S2_UNAUTHENTICATED

If S2_ACCESS or S2_AUTHENTICATED is selected, enter the value of the key as a 5-digit numeric value.

Exclusion (Remove)

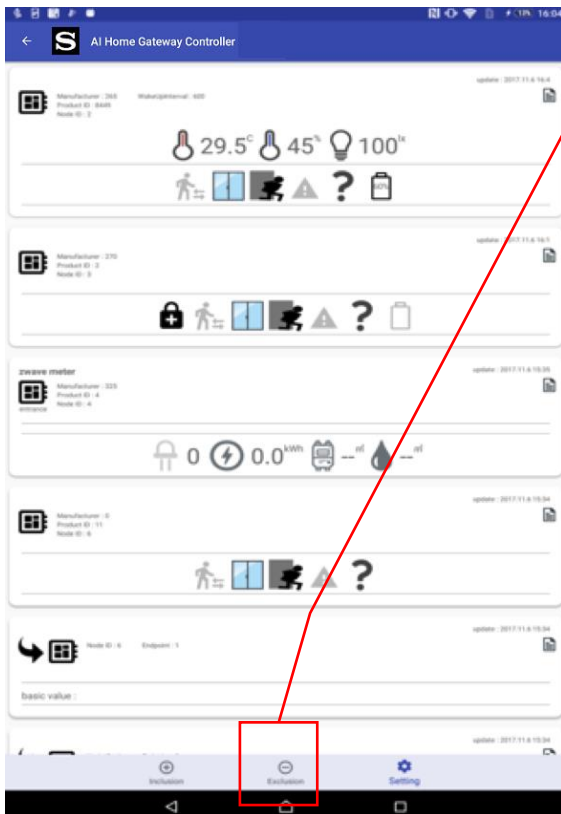

Exclusion (Removing devices)

To remove a device from the Z-Wave™ network, press the “Exclusion” button in the Android Controller Application. This will put the gateway into Exclusion Mode. A gateway operation dialog will appear in the Android Controller Application. The gateway operation dialog will be displayed during the Exclusion Mode.

To abort the Exclusion, press the “Abort” button in the gateway operation dialog, or wait for one minute and the Exclusion Mode will automatically stop. When the Exclusion Mode has stopped, the gateway operation dialog will automatically disappear.

Lock/Unlock Operation

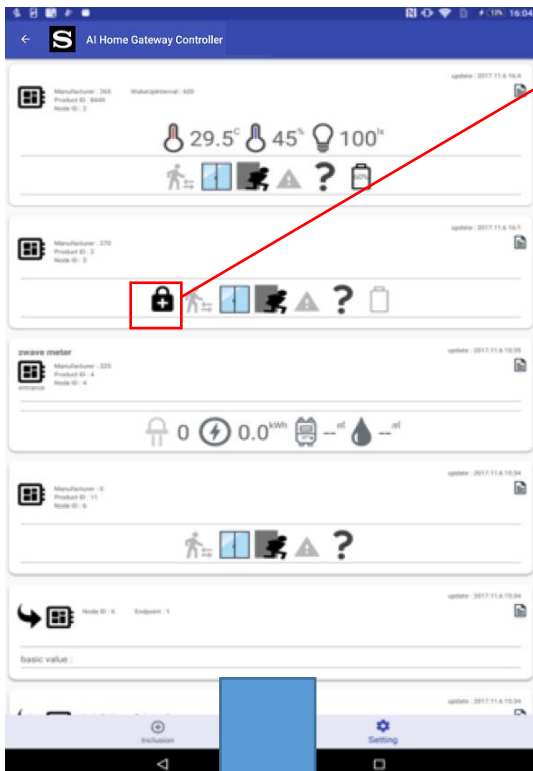

When you tap the lock status icon, Lock / Unlock Operation dialog is displayed.

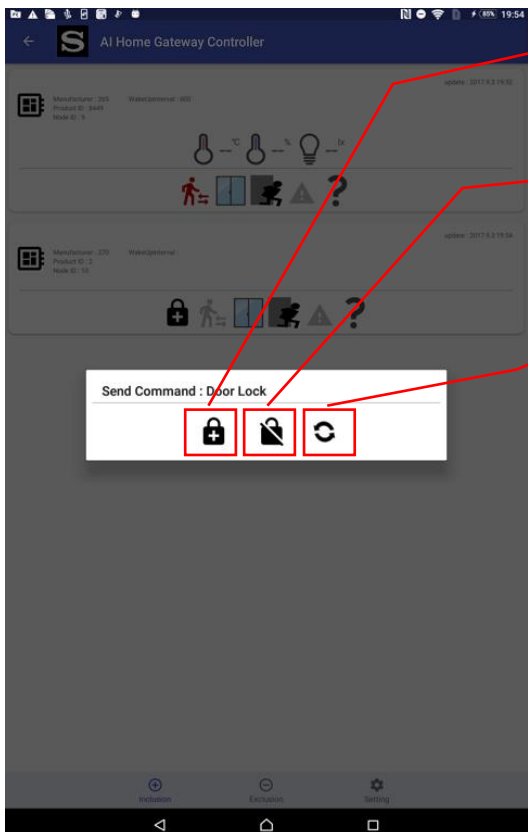

Send an instruction to lock to the Gateway.

Send an instruction to unlock to the Gateway.

Update the lock status.

Send Command

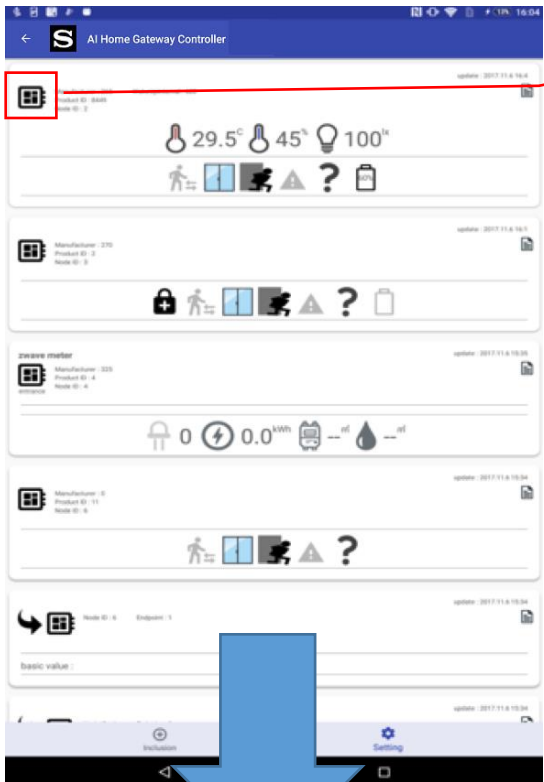

When the Device button is tapped, the "Send Command" dialog is displayed.

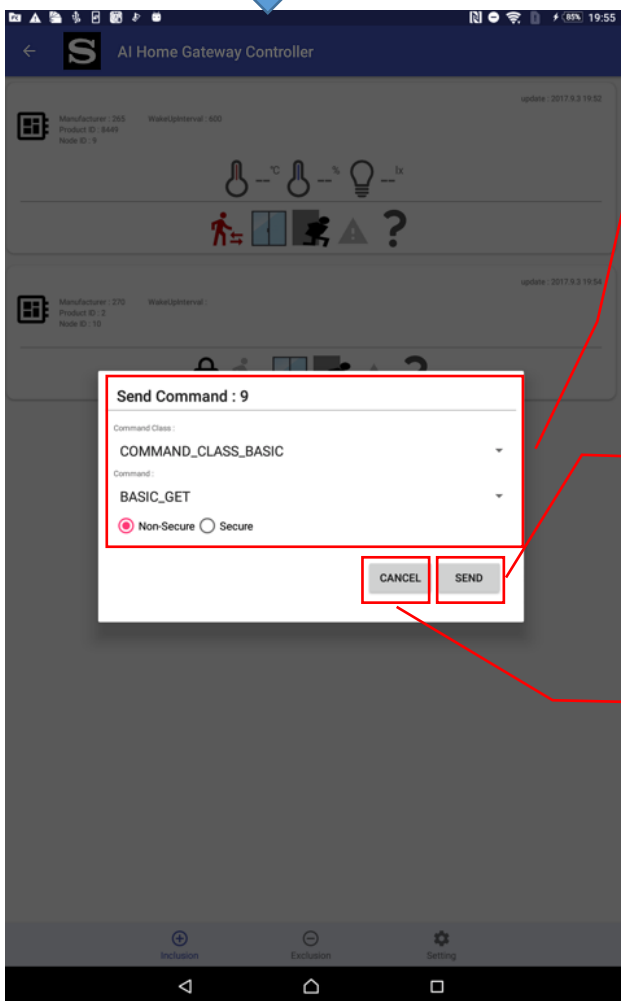

For the tapped device, select the command class and enter the necessary information to be transmitted.

Send the command currently entered.

Cancel (The dialog disappears).

Settings



When tapping the Setting button, a Settings dialog will be displayed.

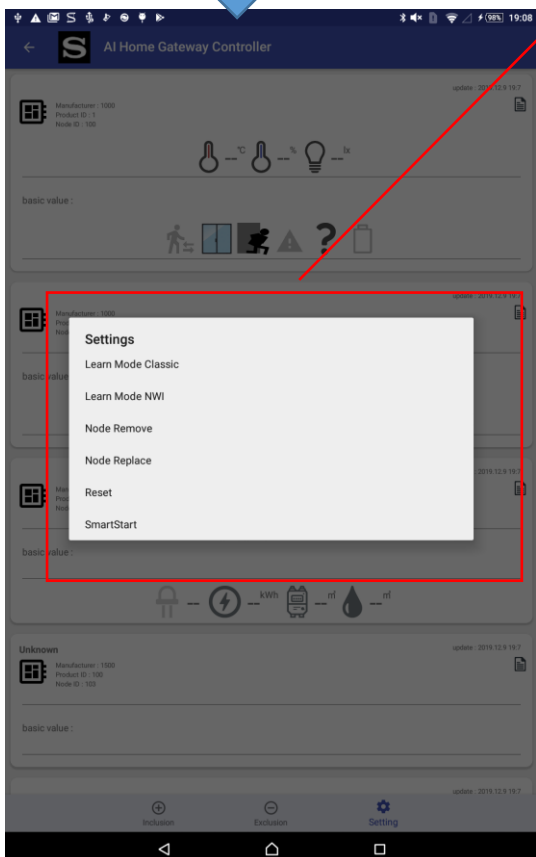
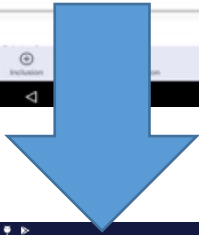

Select an item to be set.
When tapping an item, a dialog will be displayed.

- Learn Mode Classic
Set the gateway to Learn Mode(Classic)
- Learn Mode NWI
Set the gateway to Learn Mode(NWI)
- Node Remove
Remove the device with the selected Node ID
- Node Replace
Replace the device with the selected Node ID
- Reset
Factory default reset
- SmartStart
Show Provisioning List

Learn Mode

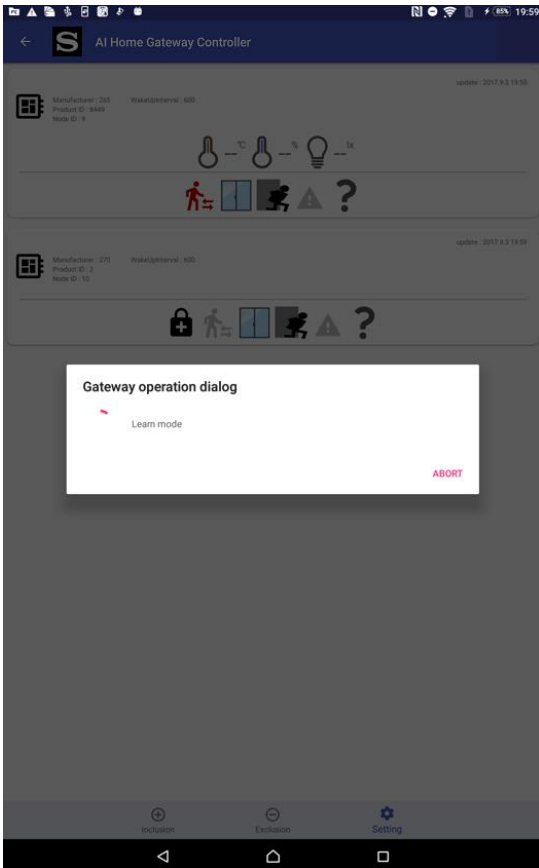

To add an IoT gateway into another Z-Wave™ network as a secondary controller or inclusion controller, press “Learn Mode Classic” or “Learn Mode NWI” in the Settings dialog. A gateway Operation dialog will appear and will be displayed during the Learn Mode.

To abort the Learn Mode, press “ABORT”. When the Learn Mode has been stopped, the gateway operation dialog will automatically disappear.

Node Remove

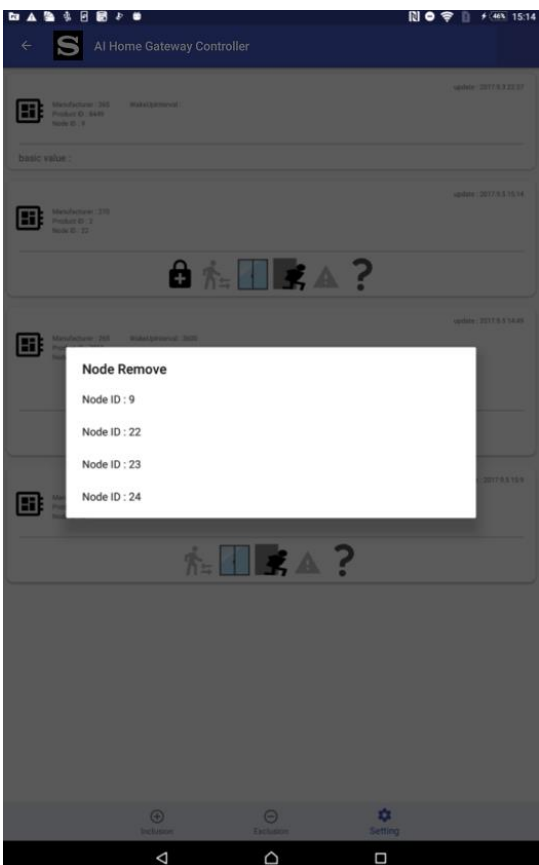

To remove a failing node from the Z-Wave™ network, press “Node Remove” in the Settings dialog, and tap the Node ID to be removed in the Node Remove dialog.

Node Replace

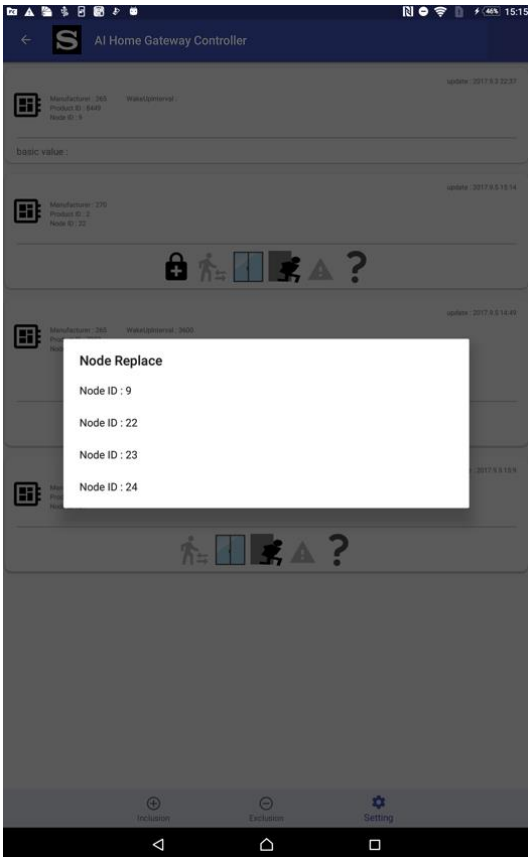

To replace a failing Node with another equivalent device, press “Replace” in the Settings dialog, and tap the Node ID to be replaced in the Node Replace dialog. The Gateway Operation dialog will appear.

Reset (Factory Default Reset)

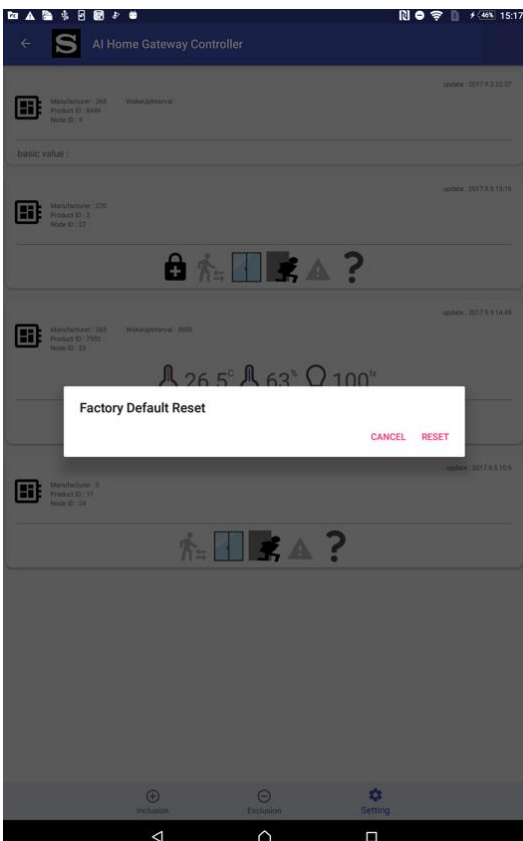

Press “RESET” in the Factory Default Reset dialog. This will reset the Z-Wave™ chip, and the gateway will show “DEVICE RESET LOCALLY NOTIFICATION” after the restart.

If this controller is the primary controller for your network, resetting it will result in the nodes in your network becoming orphaned, and it will be necessary after the reset to exclude and re-include all of the nodes in the network. If this controller is being used as a secondary controller in the network, use this procedure to reset this controller only in the event that the network primary controller is missing or otherwise inoperable.

SmartStart

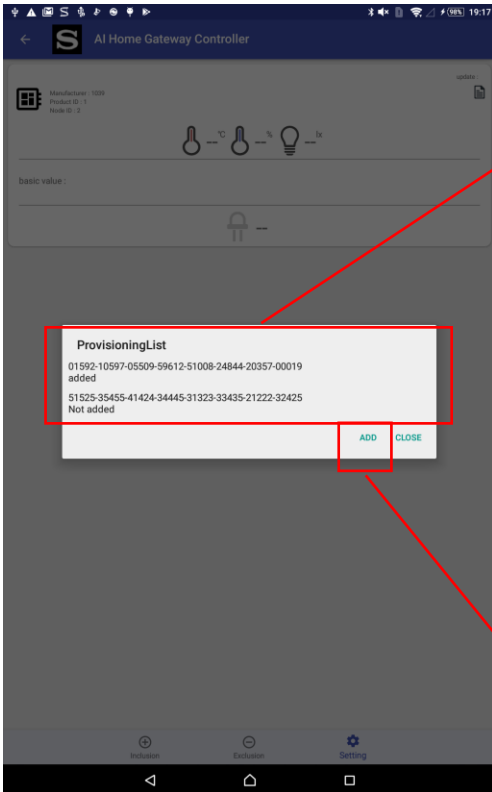

Display the registered provisioning list (DSK and inclusion status).
Press an item in the list to delete it.

Press "Add" to display the camera screen.



As the camera starts, hold it over the QR code.
Register the DSK when you correctly hold the camera over a QR code on the product label.

The complete DSK of AI Home Gateway is printed on the gift box.

Replication (Copy)

In the event that the gateway is already the controller of the Z-Wave™ network, put the gateway into Inclusion Mode, and put another controller into the Learn Mode. The Replication will begin and network information will be sent to another controller. In the event that the gateway is integrated into an existing Z-Wave™ network, put the gateway into Learn Mode, and put the existing controller into Inclusion Mode. The Replication will begin and network information will be received from the existing controller.