

Z-Wave[®] Thermostat TBZ500

Battery Powered
Z-Wave Thermostat

Installation &
Operation Guide





Table of Contents:

Thermostat Features	4
Standard HVAC System Connections	4
Thermostat compatible HVAC Systems	5
Battery Powered Operation	5
24VAC Powered Operation	5
Installation Steps	6
Remove Existing Thermostat	6
Color Wiring Table	6
Wiring Colors	7
Install Back Panel	7
Single Transformer System	7
Separate Transformer HVAC System	8
Thermostat Setup	8
Standard System Settings	8
Two stage Heat/Cool Systems	8
Single and Dual Transformer Systems (Split Systems)	9
Single Transformer System	9
Dual Transformer Systems	9
Heat Pump HVAC System Wiring	10
Thermostat Setup: Heat Pump HVAC Systems	11
Single Stage Heat/Cool Systems	11
Two Stage Heat/Cool Systems	11
Mount the Thermostat	12
Battery Powered Thermostat	12
Thermostat Setup: Configure for HVAC System	13
Preset HVAC System Settings	13
Changing the HVAC System Setup	13
Entering Menu Mode	13
Thermostat Menu Screen	14
Menu Mode Navigation	14
System Setup Menu	14
Advanced Systems Settings Menu	15
Settings Menu Table	15 - 17
Z-Wave Installation	18
Adding the thermostat to a Z-Wave network	18
Removing the thermostat from a Z-Wave network	18
Operation Instructions	19
Backlight and Button Operation	19
System Operation Modes	19
Stage Indicators	19
Setting the System Mode	20
System Modes	20
Setting the Heating or Cooling Temperature Setpoint	21
Setpoint Change	21
Setpoint Push	21
Setting the Fan Mode	22
Thermostat Menu Mode	22
Thermostat Setup Menu	23
Thermostat System Menu	23
Z-Wave Menu	23
INFO Menu	23
Thermostat Operation	24
Minimum Run Time (MRT)	24
Minimum Off Time (MOT)	24
Z-Wave Operation	24
Thermostat Battery Operation	24
Thermostat 24VAC Operation	24
Adding the thermostat to a Z-Wave network	25
Removing the thermostat from a Z-Wave network	25
Z-Wave Command Classes	26
Compliance Statement	27
Limited Warranty	27
Return Policy	27



TBZ500 BATTERY POWERED Z-WAVE THERMOSTAT

INSTALLATION INSTRUCTIONS

The Z-Wave Thermostat (TBZ500) is a programmable, Z-Wave communicating thermostat. It can be powered using 24VAC (if both “R”&”C” wires are available at the thermostat) or using four (4) AA batteries. Using Z-Wave technology, end users have the ability to use many Z-Wave enabled control panels and Z-Wave hubs to control the thermostat, configure programming settings, as well as to display current conditions in the home or office.

Features Include:

- A fixed format display with white backlight
- Heating and cooling setup display options
- System mode (OFF, Heat, Cool, Auto, E-Heat)
- Fan mode control and display (Auto, ON)
- Changeover type for Heat Pump (HP) systems
- On-screen setup of HVAC type, Fan type
- F/C mode, and sensor calibration

Compatible with 24 VAC gas, oil, or electric heating and air conditioning systems; or gas millivolt heating systems DO NOT USE ON 120VAC SYSTEMS!

Standard Systems

- 1 Stage Heating and Cooling
- 2 Stage Heating and Cooling

Heat Pump Systems

- 1 Stage Heating and Cooling
- 2 Stage Heating and Cooling
- 2nd or 3rd Stage Aux Heating (Electric Heat Strips)

Installation Outline

- Step 1 Remove Existing Thermostat
- Step 2 Install TBZ500 Thermostat
- Step 3 Setup Thermostat to match System Type
- Step 4 Install into Z-Wave Network



Copyright © Ecolink Intelligent Technology

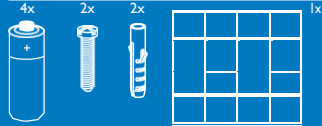
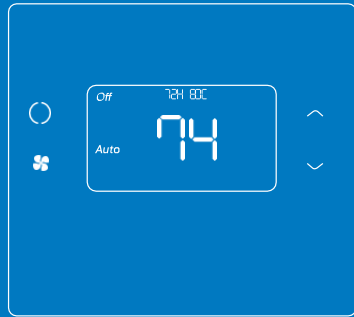

Figure 1.
Z-Wave Thermostat Front View

Box Contents

- 1 Z-Wave Thermostat
- 1 Sheet Adhesive Wiring Labels
- 2 Plastic Wall Anchors
- 2 Phillips Screws
- 4 AA Batteries



TBZ500 THERMOSTAT AT A GLANCE

This thermostat is compatible with most HVAC systems, including the following:

- 24VAC systems Note: requires both the 24VAC R and C (“common”) wires unless battery powered.
- Standard gas/oil/electric heating systems
 - 1 stage heating and cooling
 - 2 stage heating and cooling
- Heat Pump systems:
 - 1 stage heating and cooling
 - 2 stage heating and cooling
 - 2nd or 3rd stage Auxiliary heating (heat strips)
- Do NOT use for systems with line voltage controls (120/240VAC) The thermostat can either be powered by batteries or 24VAC.

Battery Powered Operation

The thermostat can be powered by four AA Alkaline batteries. The thermostat will operate for approximately two years on four AA Alkaline batteries depending on the frequency of user operations and backlight operation. Always use Alkaline batteries and replace all four at the same time with NEW batteries.

Z-Wave Operation when Battery Powered

Important Note: If the thermostat is installed on a Z-Wave network, while it is battery powered, it does not work as a Z-Wave repeater.

24VAC Powered Operation

Powering the thermostat with 24VAC power requires both the C wire (24VAC common wire - typically blue) and the R wire (24VAC hot wire - typically Red). If the C wire is not available, then batteries are required.

Note! If the thermostat is powered from 24VAC, do not install batteries!

Z-Wave Operation when 24VAC powered

If the thermostat is installed on a Z-Wave network **while it is 24VAC powered**, it operates as an always-on Z-Wave repeater.



TBZ500 24VAC OR BATTERY POWERED Z-WAVE THERMOSTAT

INSTALLATION INSTRUCTIONS

Installation Steps

- Remove old thermostat.
- Install TBZ500
- Set up the thermostat for the HVAC system
- Enroll on Z-Wave network

Remove Existing Thermostat

- **Turn off power to the HVAC system.** Usually at the HVAC system or the circuit breaker panel.
- Remove cover of old thermostat to expose the wiring terminals.
- **Take a picture of the wiring terminals! This will help with troubleshooting later if needed.**
- **Mark the wires attached to the terminals with the wiring labels included.**
 - Use the terminal labels and not the wiring color to mark the wires.
 - Remove the old thermostat base.
 - Caution! Do not let the wires slip into the wall.

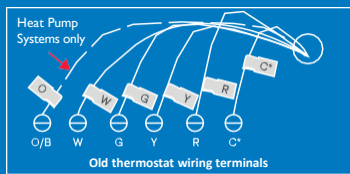

*Note:

The C wire (24V common) may not be present.

If C wire is not present, the TBZ500 must be powered by batteries.

If the C wire is present, **DO NOT INSTALL BATTERIES** in the TBZ500.

Mark the wires according to the terminal markings. There may be additional wires such as Y2, W2.

If you have RC and/or RH connections, see below. Other wires are not used.

NOTE: Taking a picture is critical if problems are encountered. This will allow reinstallation of the old thermostat and will help with troubleshooting later if needed.

Terminal	Typical Wire Color	Function
Y	YELLOW	Cool
W	WHITE	Heat
G	GREEN	Fan
R	RED	24VAC Return
C	BLUE	24V Common (typically BLUE). When the wire is present, the thermostat can be powered without batteries. When the wire is absent, the thermostat must be powered by batteries.





Wiring Colors

While the thermostat terminal markings are intended to match the wire color, (R=RED, G=GREEN, W=WHITE, Y=YELLOW) be sure to follow the terminal marking when marking the wires, even if the wire color doesn't match.

WARNING: If the existing thermostat is a mercury-containing device, it must be disposed of in compliance with federal, state, and local regulations. Many states and/or local agencies have collection or exchange programs or hazardous waste collection programs for mercury containing devices.

For more information, see the U.S. Environmental Protection Agency website at:
<http://www.epa.gov/osw/hazard/wastetypes/universal/mce.htm>

For Canada: Environment Canada and Disposing of Mercury Products at:
<https://www.ec.gc.ca/mercure-mercury/default.asp?lang=En&n=F111AAC6-1>

Install the Back Panel

Remove the back panel of the thermostat by gently prying back panel from the thermostat.

- Mount the thermostat base to the wall using the wall anchors and screws provided.
- Level as needed.
- Connect the wires according to the HVAC system type as below.

Standard Gas/Electric HVAC System Wiring

Single stage heating and cooling

R vs RC and RH Connections:

Single Transformer HVAC Systems.

Typical modern central HVAC installations have a integrated heating and cooling system with a single 24VAC transformer. For these systems, there is only one 24VAC "R" wire and it can connect to either the RC or RH terminal on the thermostat. The thermostat is supplied with an RC-RH jumper installed. **Do not remove the jumper for common transformer HVAC systems.**



Connect the wires as marked from the HVAC system to the corresponding terminals on the thermostat back.

*C wire (24VAC common) may not be present. If not, batteries must be installed.

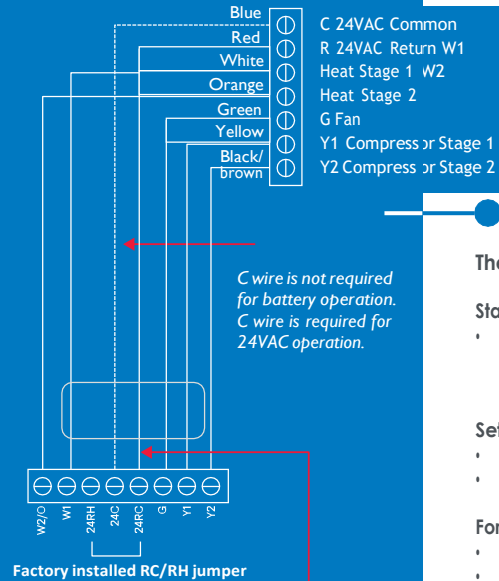

For single transformer systems, connect R wire to either RC or RH terminal. They are connected together by the factory installed jumper.

For systems with separate heating & cooling transformers, connect Heating R to RH and Cooling R to RC. **NOTE! REMOVE THE FACTORY INSTALLED RC/RH JUMPER.**

Separate Transformer HVAC Systems.

Some installations may have separate heating and cooling systems with separate 24VAC transformers. For those systems there will be a separate “R” wire for the heating system (RH) and cooling system transformers (RC).

To connect separate transformer systems, **FIRST REMOVE THE SUPPLIED RH-RC JUMPER.** Then connect the heating “R” wire to the RH terminal and the cooling “R” wire to the RC terminal on the thermostat.

Thermostat Setup:

Standard Gas/Electric HVAC Systems

- For Single Stage Heat/Cool Systems:
Go to the Menu screen by pressing and holding the FAN button for 5 seconds Press the down arrow to select the **SYSTEM** menu and press Select.

Set the following:

- **SYSTEM TYPE:** Set to **STANDARD**
- **FAN TYPE:** Set to **GAS** for typical gas furnace (fan is controlled by the furnace) Set to **ELECTRIC** for electric heat (fan on with heat call)

For Two Stage Heat/Cool Systems:

- Go to **ADVANCED SYSTEMS SETTINGS** menu.
- From the **Setup menu** screen, press and hold the Fan and Down arrow buttons for 5 seconds. Use the Down arrow button to select the following:
 - **2ND STAGE HEAT ENABLE:** Enable second stage heating output If a single stage heating system, leave this set to **N**
If a 2 stage heating system, set to **Y** to enable.
 - **2ND STAGE COOL ENABLE:** Enable second stage cooling output
If a single stage cooling system, leave this set to **N**.
If a two stage cooling system, set to **Y** to enable.

Default Thermostat Setup:

- Type: Standard HVAC
- Fan Type: Gas Heat
- 1 Stage heating
- 1 Stage cooling

No Setup change required for this configuration



SINGLE AND DUAL TRANSFORMER SYSTEMS (SPLIT SYSTEMS)

HVAC systems may have one or two transformers. The “R” wire connects differently depending on the system.

Wire	Terminal
Y	Connect to the Y1 terminal
G	Connect to the G terminal
R	Connect to either RC or RH terminals (Except for Dual Transformer Systems, See Next Page)
C	Connect to the C terminal. C wire (24VAC common) may not be present. If not present, batteries MUST be installed.
W	Connect to the W1 terminal

NOTES: Ensure that the appropriate wires are screwed into the terminal blocks firmly. Gently pull on the wires to confirm the connection. Push all excess wiring back into the wall opening.

Connect the wires from the HVAC system to the corresponding terminals on the thermostat back terminal block. Use the table below as a guideline for connecting the wires.

Wire	Terminal
Y2	Connect to the Y2 terminal (2-stage systems only)
Y or Y1	Connect to the Y1 terminal
G	Connect to the G terminal
COOL Rc	Connect to RC terminal
C	Connect to C terminal (Cooling System C Wire, NOT Heating System C Wire)
HEAT Rh	Connect to RH terminal
W or W1	Connect to W1 terminal
W2	Connect to W2 terminal (2-stage system only)

IMPORTANT!: for separate rc/rh systems, the internal rc=rh jumper must be cut on the back of the thermostat’s printed circuit board.

Single Transformer System

Most HVAC systems have a single 24VAC transformer. For these systems, there is only one “R” wire and it can be connected to either the thermostat’s RC or RH terminal as these are internally jumpered together. If installing a Standard HVAC system, connect the wires from the HVAC system to the corresponding terminals on the thermostat back terminal block. Use the table below as a guideline for connecting the wires.

Dual Transformer Systems

For HVAC systems that have separate heating and cooling systems, each with their own 24VAC transformers, there will be an “R” wire from the heating system and an “R” wire from the cooling system. For dual transformer systems, connect the “C” wire from the cooling system to the thermostat’s “C” terminal. **DO NOT CONNECT THE “C” WIRE FROM THE HEATING SYSTEM.**



Heat Pump HVAC System

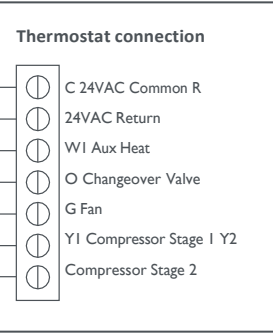

Heat Pump HVAC System Wiring

Single stage heating and cooling
 Typical thermostat wiring colors.
 Caution: verify that original wiring matches. Colors may be different.

Note! If you get heating when you expected cooling or vice versa, change the Change Over type to the opposite setting.

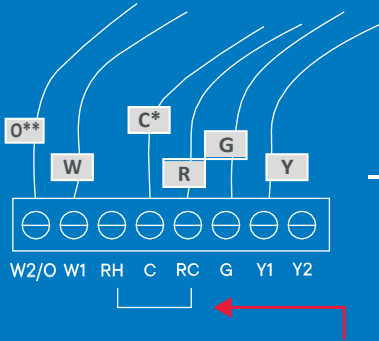

Factory installed RC and RH jumper.
 Do not remove

Connect the wires as marked from the HVAC system to the corresponding terminals on the thermostat back.

*C wire (24VAC common) Heat Pump systems usually have the C wire connected to the thermostat. If there isn't a C wire, batteries must be installed.

** O (Orange) or B (Brown) wire (changeover valve) connect to the W2/O terminal on the thermostat.

NOTE: Be sure to set the correct changeover operation (O = changeover with Cool, B = changeover with Heat) in the SETUP menu.

Connect the R wire to either RC or RH terminal.

Thermostat back

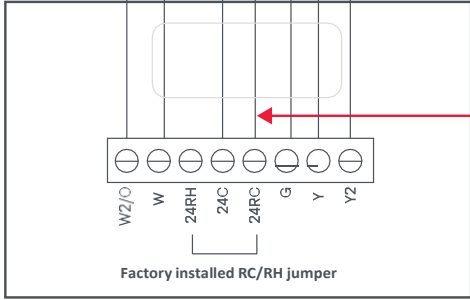

Factory installed RC/RH jumper

Most Heat Pump systems have the C wire and the thermostat can be power by the 24VAC from the HVAC system.

Batteries are not required for 24VAC powered systems. If there is not a C wire installed, the thermostat MUST be powered from batteries.

Connect the R wire to either the RC or RH terminal.

DO NOT REMOVE THE RC/RH JUMPER





THERMOSTAT SETUP:

Heat Pump HVAC Systems

For Single Stage Heat/Cool Systems:

Go to the Menu screen by pressing and holding the FAN button for 5 seconds Press the down arrow to select the SYSTEM menu and press Select. Set the following:

System type: Set to HEAT PUMP

Change over: For changeover with cooling systems (Orange wire): set to WITH COOL (most common and default setting) For changeover with heating systems (Brown wire): set to WITH HEAT

You must configure the thermostat's changeover valve setting to work correctly with your HVAC system.

Check your system information to be sure and note the color of original thermostat wire and the terminal it was connected to. No matter what the old stat connection was (O or B), connect the wire to the thermostats W2/O terminal.

For Two Stage Heat/Cool Systems:

Go to ADVANCED SYSTEMS SETTINGS menu. From the Setup menu screen, press and hold the Fan and Down arrow buttons for 5 seconds. Use the Down arrow button to select the following:

Auxheat: If you have auxiliary heat strips, set this to Y to enable. (Default is Y)

2nd stage head enable: Enable second stage heating outputs If a single stage heating system, leave this set to N. If a two stage heating system, set to Y to enable.

2nd stage cool enable: Enable second stage cooling outputs If a single stage cooling system, leave this set to N. If a two stage cooling system, set to Y to enable.

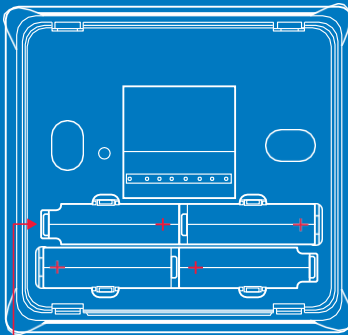
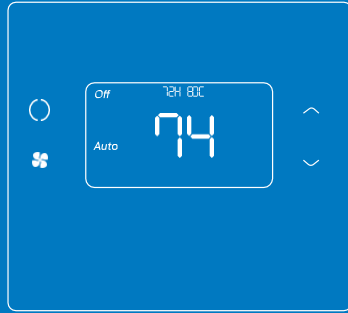

Install batteries
Watch polarity!

Finish Wiring

If you have additional wires for 2 stage systems (W2, Y2), see the wiring diagrams on page 5 and 6. Check that the wires are screwed into the terminal blocks firmly. Gently pull on the wires to confirm the connection. Push all the excess wiring back into the wall.

Mount the Thermostat

24VAC Powered Thermostat: If the thermostat is 24VAC powered (24VAC common “C” wire is connected), **DO NOT INSTALL BATTERIES!**

- Install the thermostat on to the base.
- After all connections are made and thermostat is mounted, turn on power to the HVAC system/thermostat by either re-energizing the circuit breaker in the breaker panel or by plugging in the HVAC system back in to the 120VAC wall outlet.
- **Battery Powered Thermostat:** If the thermostat is battery powered (NO 24VAC common “C” wire connected), install 4 NEW Alkaline AA batteries into the back of the thermostat.
- Install the thermostat on to the base.
- After all connections are made and thermostat is mounted, turn on power to the HVAC system/thermostat by either re-energizing the circuit breaker in the breaker panel or by plugging in the HVAC system back in to the 120VAC wall outlet.





THERMOSTAT SETUP: CONFIGURE FOR HVAC SYSTEM

The thermostat must be set up for the correct HVAC system type and configuration for proper operation.

Preset HVAC System settings

The thermostat is preset for the following typical HVAC system configuration:

- HVAC system type: Standard gas/electric
- HVAC fan type: Gas heat
- HVAC heating stages: one
- HVAC cooling stages: one

If the thermostat is installed on this type HVAC system, the System setup does not need to be changed.

Installation is complete

For thermostats installed on a Heat Pump HVAC system or any HVAC configuration other than the preset settings, the System settings need to be changed in the SYSTEM setup menu to match the HVAC system.

Changing the HVAC System Setup

To change the thermostats HVAC system settings, first select the Menu Screen and then select the SYSTEM menu. Follow instructions below to access the SYSTEM menu.

Entering Menu Mode

To change the System setup, go to the thermostats Menu Mode and select SYSTEM. From there select the correct HVAC settings to match the installation type. Press and hold the FAN button to enter the Menu Mode. SETUP is the first menu item displayed. Press the down button to advance to the SYSTEM screen.

Note:

To conserve battery life, the thermostat backlight turns off after a short time of no activity.

The first press of any button will turn on the backlight but will not initiate any action other than turning on the backlight. Press the button again to initiate the action desired. If the backlight is already on, button presses work with the first press.

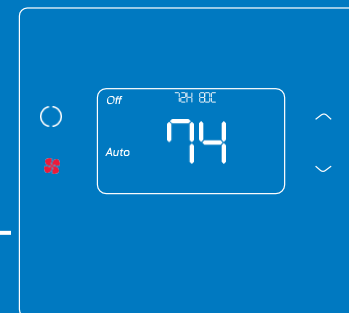



ADVANCED SYSTEM SETTINGS MENU

The Advanced System Settings Menu provides for addition system setup options. These settings can affect system operation and should only be changed by qualified HVAC installers.

- To access the Advanced System Settings menu, first press and hold the Fan button to get to the MENU screen. Continue to hold down the Fan button and press and hold the Down Arrow button for 5 seconds.
- The first menu item in the Advance System Settings menu “Display Lock”, will be displayed. Use the Up/Down arrow buttons to scroll through the menu options to the desired setting.
- Press “Select” (Mode) button to change a setting. Once it begins to flash, use the Up/Down buttons to select the desired setting.
- Press the SELECT button to accept the new setting (flashing will stop).

Feature	Description	Range	Default Setting
Display Lock	Allows the thermostat buttons to be locked. When the buttons are locked, none of the thermostat buttons will function as normal. To unlock the thermostat when Display Lock is enabled, press and hold the FAN button for 5 seconds to access the Setup screen (it's the only button that works in the lock mode). Access the Advanced Settings Menu (as above) to turn the Display Lock off.	Y or N	N
Test Mode	Test mode shortens the system built-in delays (like MOT and MRT) Y = Test mode on. Reduces all delays to 10 seconds for quicker system testing N = Test mode off. Normal system delays	Y or N	N
Aux Heat Enable (Heat Pump Systems only)	**Becomes available when System Type: Heat Pump is selected in standard menu. Enables the auxiliary heat operation. Typically the auxiliary heat will be heat-strips in a heat pump system.	Y or N	Y
2nd Stage Heat Enable	Enables the second stage heat operation	Y or N	Y
2nd Stage Cool Enable	Enables the second stage cool operation	Y or N	Y
Minimum run time	Sets the Minimum Run Time (MRT) delay before a heating/cooling cycle can turn off.Sets heating/cooling cycle time. Prevents rapid on/off cycling.	1-9	3



Feature	Description	Range	Default Setting
Minimum Off time	Sets the Minimum Off Time (MOT) delay before another heating/cooling cycle can begin. Provides compressor short cycle protection. "Wait" is displayed on screen when active.	5-9 Minutes	5
Heat Setpoint Max.	Sets the maximum heating setpoint value. Will not ramp or accept setpoints higher than this maximum	55F to 96F (4C to 43C)	90F (32C)
Cool Setpoint Min.	Sets the minimum cooling setpoint value	60F to 99F (6C-45C)	60F (15C)
Heat Blower Off Delay	Sets the system blower delay off time after a heat call ends (fan purge)	0 to 9 seconds	0 (off)
Cool Blower Off Delay	Sets the system blower delay off time after a cool call ends (fan purge)	0 to 9 seconds	0 (off)
Heat - Cool Delta	Sets the minimum separation between heating and cooling setpoints. Note: Attempts to lower cooling setpoint below the heating setpoint will PUSH the heating setpoint down to maintain this separation. The same applies to setting the heating setpoint above the cooling setpoint, it will PUSH the cooling setpoint up to maintain the setpoint delta separation	3 to 15 degrees	3F (1C)
Heating Stage 1 on Threshold	Sets the delta from setpoint that stage 1 heating starts	1 to 6 degrees	1
Heating Stage 1 Off Threshold	Sets the delta from setpoint that stage 1 heating stops. Stage 1 turns off at setpoint + Delta Stage 1.	0 to 5 degrees	0
Heating Stage 2 On Threshold	Sets the delta from setpoint that stage 2 heating starts	2 to 7 degrees	2
Heating Stage 2 Off Threshold	Sets the delay from setpoint that stage 2 heating stops. Stage 2 turns off at setpoint + Delta Stage 2.	0 to 6 degrees	0
Aux Heat On Threshold	Sets the delta from setpoint that stage 3 heating starts	3 to 8 degrees	3
Aux Heat Off Threshold	Sets the delta from setpoint that stage 3 heating stops. Stage 3 turns off at setpoint + Delta Stage 3	0 to 7 degrees	0
Cooling Stage 1 On Threshold	Sets the delta from setpoint that stage 1 cooling starts.	1 to 7 degrees	1



Feature	Description	Range	Default Setting
Cooling Stage 1 Off Threshold	Sets the delta from setpoint that stage 1 cooling stops. Stage 1 turns off at setpoint - Delta Stage 1	0 to 6 degrees	0
Cooling Stage 2 On Threshold	Sets the delta from setpoint that stage 2 cooling starts.	2 to 8 degrees	2
Cooling Stage 2 Off Threshold	Sets the delta from setpoint that stage 2 cooling stops. Stage 2 turns off at setpoint - Delta Stage 2.	0 to 7 degrees	0
Restore Defaults	Restores all settings to factory defaults. Press Yes to restore defaults Press No to exit and not restore defaults	Y or N	N

Factory Default

Please use this procedure only when the Z-Wave Primary Controller is missing or otherwise inoperable. To reset the TBZ500's Z-Wave parameters to Factory Settings (both Z-Wave and HVAC settings):

1. Remove power from the TBZ500.
2. Restore power to the TBZ500.
3. When "TBZ500" appears on the screen, hold down the MODE and FAN buttons at the same time.
4. Release the buttons when RESET appears on the Status Line.
5. Once the TBZ500 resets the Z-Wave and HVAC settings, a DONE confirmation message will appear on the screen before the thermostat self-reboots.





Z-Wave Installation

Adding the thermostat to a Z-Wave network.

6. Follow the instructions provided with your system for enrolling the thermostat.
7. Press and hold the FAN button on the Thermostat until the screen changes to the Menu screen.
8. Press the UP button until ZWAVE is shown in the Status Display line then press Select.
9. INSTALL should be shown on the status line.
10. When instructed by your system installation to add the thermostat to the network press the "Select" button to install. Wait until SUCCESS or FAILED is shown on the status display.
11. Press Done on the Thermostat to exit the ZWAVE screen.
12. Press Done on the Thermostat again to exit the Menu screen.
13. Once enrolled on your system's network, continue to follow the instructions provided to complete the enrollment and naming of the thermostat.
 14. The indicator should be shown on the Thermostat Main screen indicating the thermostat has successfully been enrolled into the Z-Wave network.

Removing the thermostat from a Z-Wave network.

It may be necessary to remove and/or reinstall the thermostat from a Z-Wave network if the thermostat has been previously installed on another network. Follow the instructions supplied with your Z-Wave system to remove/uninstall a Z-Wave device. When the system instructs you to press and release the Z-Wave button on the thermostat, follow these steps:

1. Press and hold the FAN button for 3 seconds until the Menu screen is displayed.
2. Press the UP arrow button to scroll to the "ZWAVE" menu.
3. Press "Select" to select the ZWAVE screen.
4. The display will show "REMOVE" in the text line.
5. Press "Select" to perform the remove action.
6. "WAIT" will be displayed in the text line. The remove operation is in process.
7. "SUCCESS" will be display when the thermostat has been excluded from the network.
8. Press "Done" to exit back to the thermostat screen.
9. Thermostat is now ready to be added to any Z-Wave network.





TBZ500 24VAC OR BATTERY POWERED Z-WAVE THERMOSTAT

OPERATION INSTRUCTIONS

Backlight and Button Operation

The thermostat backlight is normally set to go out after 10 seconds of no button presses to conserve battery power. If the backlight is off, the first button press of any button will only turn on the backlight. Once the backlight is on, the buttons function normally.

System Operation Modes

 displayed = System is ON and heating.
If flashing, minimum run time (MRT) is active

 displayed = System is ON and cooling.
If flashing, minimum run time (MRT) is active

Stage Indicators

- “1” = Stage 1 heating or cooling is ON
- “2” = Stage 2 heating or cooling is ON
- “3” = Stage 3 heating (Aux Heat) is ON

For Heat Pump systems only:

- “Heat-E” = Emergency heat mode active

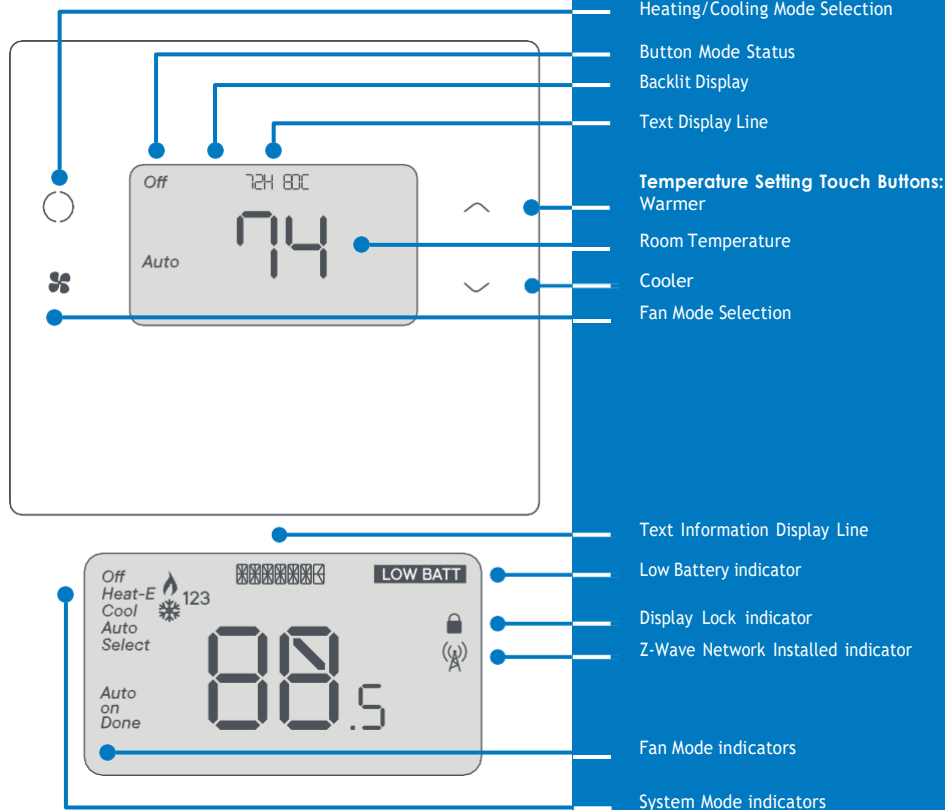

TBZ500 Display

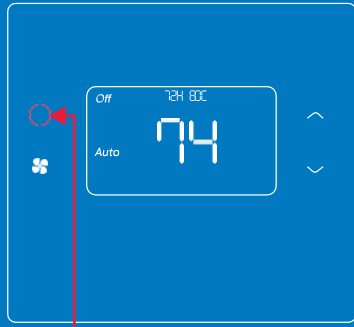

Press MODE
button to change
system mode

SETTING THE SYSTEM MODE

System Modes

- **Off:** System is off. No heating or cooling will come on. If system was on, it will turn off immediately.
- **Heat:** Only heating will occur.
- **Cool:** Only cooling will occur.
- **Auto:** Heating or cooling will come on according to the heating and cooling setpoints. The system will automatically switch between heating and cooling modes as needed to maintain the setpoints.
- **Special Heat Pump Mode:** Emergency Heat.
- **Heat-E:** An additional system mode, “Heat-E” for Emergency Heat will be displayed if the HVAC System Type is set to Heat Pump. If there is a compressor failure with the Heat Pump system, setting the mode to Emergency Heat will allow the supplemental Aux Heat to come on first whenever there is a call for heating. It also disables the compressor output to prevent further damage to the HVAC system.

Caution! Emergency Heat should only be used for emergencies until the HVAC system can be repaired. Running the system in Emergency Heat mode is commonly the most expensive mode since only the electric heat strips are being used instead of the more efficient heat pump compressor.





SETTING THE HEATING OR COOLING TEMPERATURE SETPOINT

Setpoint Change

To change the setpoint, press the Up or Down arrow buttons. The screen will switch to the setpoint change screen (as above) and show the current setpoint of the current heating or cooling mode. Adjust setpoint temperature up or down with the arrow buttons.

Note! When in the Setpoint Change screen, pressing the MODE button will switch the setpoint being displayed between the Heat and Cool setpoints.

Setpoint Push: The cooling setpoint cannot be set below the heating setpoint. The thermostat will “push” the heating setpoint lower if the cooling setpoint is set below the current heating setpoint. A 3 degree separation is maintained between the heating and cooling setpoints. The same is true for raising the heating setpoint above the cooling setpoint. The thermostat will “push” the cooling setpoint up to maintain the 3 degree separation.

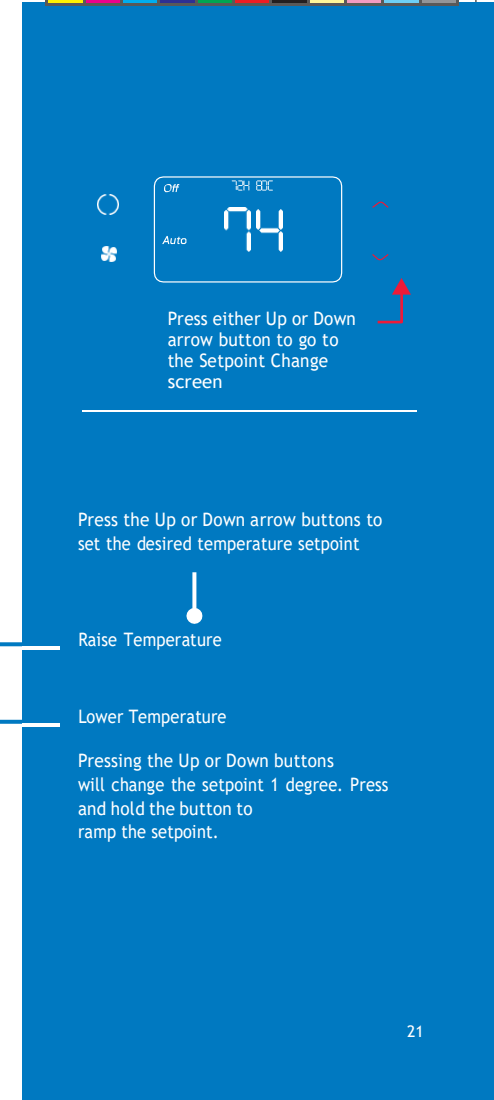
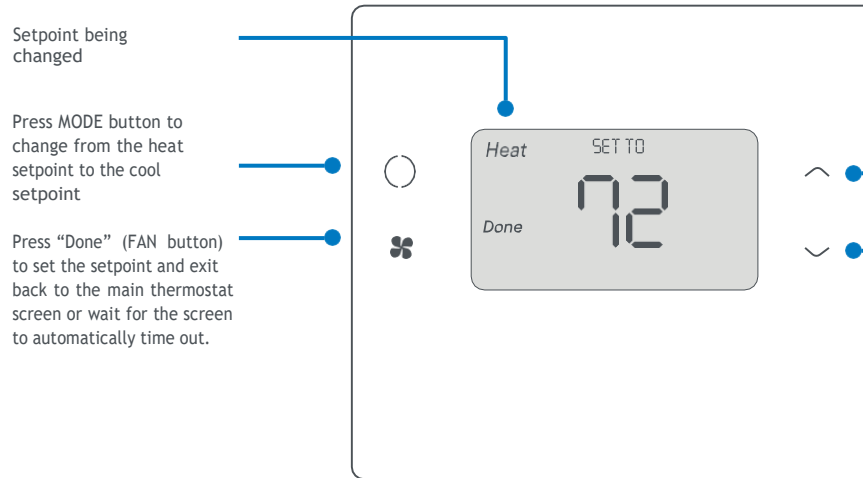

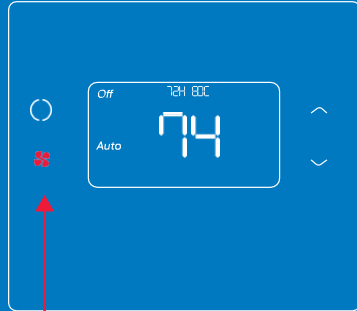

SETTING THE FAN MODE

Fan Modes

- **Auto:** Fan automatically operated by the HVAC system. (normal setting)
- **On:** Manual Fan mode. Fan stays on until mode is changed back to Auto, independent of the heating or cooling system operation.

Press the FAN button to change the Fan mode

Menu item display

Press "Select" to go to the selected menu item screen

Press "Done" to go back to the Thermostat Main Screen

Use the UP/DOWN buttons to select the desired menu item

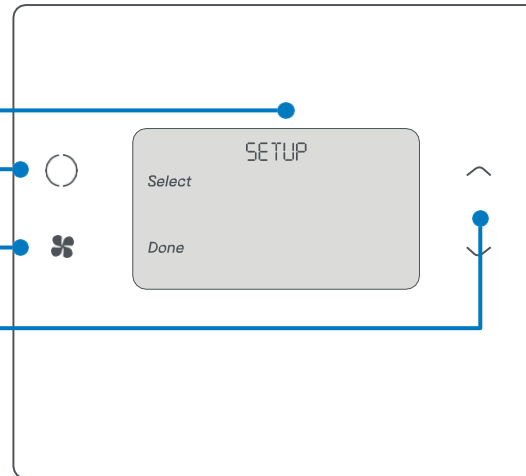

THERMOSTAT MENU MODE

The Thermostat has a menu of setup and information displays. To change to the Menu Mode, press and hold the FAN button for 5 seconds. The display will change to the Menu Mode and display the Setup screen. Use the Up/Down arrow buttons to scroll through other menu items.

 Press and hold the FAN button for 5 seconds to go to the **Menu Mode** screen



SETUP menu

User preference settings.

- **Fahrenheit or Celsius.**
Select the temperature display mode.
- **Backlight timeout.**
Sets the time from last button press that the backlight will turn off. Range: 10 (default) -30 seconds. Note: long backlight timeouts will reduce battery life. If the thermostat is powered from 24VAC, the backlight timeout can be set to "0" which will keep the backlight on continuously.
- **temperature sensor calibration.**
Change the temperature calibration by +/- 7 degrees. Use the Up/Down arrow buttons to change to the desired temperature displayed.
- **Status Line Display.**
Select Setpoints or Relative Humidity to be displayed on the upper status line.

SYSTEM menu

- **System type**
Select the system type, STANDARD or HEAT PUMP TYPE (Standard systems only).
- Select fan type: **gas** (typical default setting) or **electric**
- **Change over type** (Heat Pump systems only).
Select the Changeover type: Changeover WITH COOL (typical default setting) or Changeover WITH HEAT.

Z-WAVE menu

This menu item allows the thermostat to be enrolled to the Z-Wave network. Follow the instructions shown in the Z-Wave® Operation section (page 18) to enroll the Thermostat onto the network.

INFO menu

The INFO menu displays information about the thermostat. Use the Up/Dn buttons to scroll through the various items.



Menu Mode Screen

- **Setup** (user preference settings)
- **System** (HVAC system setup)
- **Zwave** (Z-Wave network install or remove)
- **Info** (Displays thermostat version and setup info)

Thermostat information displayed:

- **Version:** Thermostat firmware version
- **Zwave:** Z-Wave firmware version
- **Node ID:** Z-Wave Node ID
- **Home ID:** Z-Wave Home ID
- **System type:** displays current System Type settings (Standard or Heat Pump)
- **If System Type = Standard**
FAN TYPE displays current Fan Type setting
- **If System Type = Heat Pump**
CHANGEOVER TYPE displays current Change Over valve (reversing valve) setting
- **AC or Battery Powered:** AC POWER will be displayed if power by 24VAC

THERMOSTAT OPERATION

Minimum Run Time (MRT)

The thermostat has a Minimum Run Time (MRT) delay after the start of any heating or cooling call. This minimum run time assures even heating and cooling cycles. The MRT will keep the system on, even if it reaches the setpoint room temperature, or you change the setpoint to a temperature that would satisfy the call, until the MRT expires. Changing the Mode to OFF will cancel the MRT and the system will turn off immediately. The MRT can be adjusted in the Advanced Settings menu of the thermostat.

Note: When MRT is active, the heating or cooling icon will be flashing.

Minimum Off Time (MOT)

The thermostat has a Minimum Off Time (MOT) delay after any heating or cooling cycle ends. This delay prevents rapid heating/cooling cycles and also provides “short cycle protection” for the system compressor. This delay may be noticeable when you change a setpoint and it does not respond immediately due to the MOT delay timer preventing the system from restarting. The MOT delay time can be adjusted in the Advanced Settings menu of the thermostat but there is a minimum of a 5 minute delay to assure compressor protection.

Note: When MOT is active, the thermostat Status Display shows “WAIT”.

Z-WAVE® OPERATION

Thermostat Battery Operation: If the thermostat is installed in a Z-Wave network while powered by batteries, it will be enrolled as a Z-Wave FLiRs type device. This is a power saving mode that conserves the batteries by keeping the radio asleep most of the time. However, in this mode, the thermostat does not act as a repeater/router in the Z-Wave network.

Thermostat 24VAC Operation: If the thermostat is installed in a Z-Wave network while powered by 24VAC, it will be enrolled as an always-listening device and can act as a router node in the Z-Wave network.

Caution! Once installed in a Z-Wave network, if you change how the thermostat is powered (from batteries to 24VAC or vice versa), you must remove and re-enroll the thermostat in the Z-Wave network for it to work correctly.



SmartStart Inclusion – Adding the thermostat to a Z-Wave Network

The TBZ500 is SmartStart enabled and can be added into a Z-Wave network by scanning the Z-Wave QR Code present on the product with a controller providing SmartStart inclusion. No further action is required and the SmartStart product will be added automatically within 10 minutes of being switched on in the network vicinity. The SmartStart QR code can be found on the back of the thermostat, side of the package, or also inserted as an insert card/sticker. The sticker contains the full DSK string. It's important that if you plan to use DSK that you keep this label in a safe place you'll remember. If your system does not support SmartStart, you can still enroll your thermostat using classic inclusion.

Classic Inclusion - Adding the thermostat to a Z-Wave network.

1. Follow the instructions provided with your system for enrolling the thermostat.
2. Press and hold the **FAN button** on the Thermostat until the screen changes to the Menu screen.
3. Press the UP button until ZWAVE is shown in the Status Display line then press Select.
4. INSTALL should be shown on the status line.
5. When instructed by your system installation to add the thermostat to the network press the “Select” button to install. Wait until SUCCESS or FAILED is shown on the status display.
6. Press Done on the Thermostat to exit the ZWAVE screen.
7. Press Done on the Thermostat again to exit the Menu screen.
8. Once enrolled on your system's network, continue to follow the instructions provided to complete the enrollment and naming of the thermostat.
9. The  indicator should be shown on the Thermostat Main screen indicating the thermostat has successfully been enrolled into the Z-Wave network.

Removing the thermostat from a Z-Wave network.

It may be necessary to remove and/or reinstall the thermostat from a Z-Wave network if the thermostat has been previously installed on another network. Follow the instructions supplied with your Z-Wave system to remove/uninstall a Z-Wave device. When the system instructs you to press and release the Z-Wave button on the thermostat, follow these steps:

1. Press and hold the FAN button for 3 seconds until the Menu screen is displayed.
2. Press the UP arrow button to scroll to the “ZWAVE” menu.
3. Press “Select” to select the ZWAVE screen.
4. The display will show “REMOVE” in the text line.
5. Press “Select” to perform the remove action.
6. “WAIT” will be displayed in the text line. The remove operation is in process.
7. “SUCCESS” will be displayed when the thermostat has been excluded from the network.
8. Press “Done” to exit back to the thermostat screen.
9. Thermostat is now ready to be added to any Z-Wave network.

Z-WAVE COMMAND CLASSES

Z-Wave Command Classes	TBZ500	
COMMAND_CLASS_BASIC	*	
COMMAND_CLASS_ZWAVEPLUS_INFO_V2	*	
COMMAND_CLASS_ANTITHEFT_V2	*	
COMMAND_CLASS_ASSOCIATION_GRP_INFO	*	
COMMAND_CLASS_ASSOCIATION_V2	*	
COMMAND_CLASS_BATTERY	*	
COMMAND_CLASS_DEVICE_RESET_LOCALLY	*	
COMMAND_CLASS_FIRMWARE_UPDATE_MD_V2/V3	*	- V3
COMMAND_CLASS_MANUFACTURER_SPECIFIC_V2	*	- V2
COMMAND_CLASS_MULTI_CMD	*	
COMMAND_CLASS_POWER_LEVEL	*	
COMMAND_CLASS_SENSOR_MULTILEVEL_V5	*	- V5
COMMAND_CLASS_THERMOSTAT_FAN_MODE	*	
COMMAND_CLASS_THERMOSTAT_FAN_STATE	*	
COMMAND_CLASS_THERMOSTAT_MODE_V3	*	- V3
COMMAND_CLASS_THERMOSTAT_OPERATING_STATE_V2	*	- V2
COMMAND_CLASS_THERMOSTAT_SETPOINT_V2/V3	*	- V3
COMMAND_CLASS_VERSION_V2	*	
COMMAND_CLASS_SECURITY_2	*	
COMMAND_CLASS_TRANSPORT_SERVICE_V2	*	
COMMAND_CLASS_SUPERVISION	*	
COMMAND_CLASS_CONFIGURATION_V2	*	- V2



Association groups

The TBZ500 supports 3 groups and 5 associations per group.

Group 1 Association Alerts are to notify an associated device of a thermostat generated change. Thermostat generated changes are those changes that originate at or by the thermostat. The general classifications of thermostat generated changes are:

- User interface changes - Setpoints, Mode, Fan Mode, Occupied Mode
- Operational changes - Operating State, Fan State (See Configuration parameter #24 for details)
- COMMAND_CLASS_CONFIGURATION changes - See the COMMAND_CLASS_CONFIGURATION table for additional unsolicited alerts
- Setpoint Push - When a setpoint is pushed to maintain the HC-Delta separation
- Battery Status when the battery reaches the predefined thresholds

Group 2 Association Alerts will send a BASIC_SET 0xFF when a Cool Call starts and a BASIC_SET 0x00 when the Cool Call ends

Group 3 Association Alerts will send a BASIC_SET 0xFF when a Heat Call starts and a BASIC_SET 0x00 when the Heat Call ends



Z-Wave Configurations

There are configuration parameters accessible via the COMMAND_CLASS_CONFIGURATION.

Note all temperature related parameters are in degrees F.

Config Parameter #	Description	Length (bytes)	Send Unsolicited on change	Default Value	Read values	Write values
1	System Type 4	1	N	0	0 = Standard 1 = Heat Pump	0 = Standard 1 = Heat Pump
2	Fan Type 4	1	N	0	0 = Gas (No fan w/Heat) 1 = Electric (Fan w/Heat)	0 = Gas (No fan w/Heat), 1 = Electric (Fan w/Heat)
3	Change Over Type 4	1	N	0	0 = CO w/cool 1 = CO w/heat	0 = CO w/cool 1 = CO w/heat
4	2nd Stage Heat Enable 4	1	N	0	0 = Disabled 1 = Enabled	0 = Disabled 1 = Enabled
5	Aux Heat Enable 4	1	N	1	0 = Disabled 1 = Enabled	0 = Disabled 1 = Enabled
6	2nd Stage Cool Enable 4	1	N	0	0 = Disabled 1 = Enabled	0 = Disabled 1 = Enabled
7	C/F Type	1	N	1	0 = Centigrade 1 = Fahrenheit	0 = Centigrade 1 = Fahrenheit
8	MOT 5	1	N	5	5-9	5-9
9	MRT 5	1	N	3	3-9	3-9
10	Setpoint H/C Delta	1	N	3	3-15	3-15
11	H Delta Stage 1 ON	1	N	1	1-6	1-6
12	H Delta Stage 1 OFF	1	N	0	0-5	0-5
13	H Delta Stage 2 ON	1	N	2	2-7	2-7
14	H Delta Stage 2 OFF	1	N	0	0-6	0-6
15	H Delta Aux ON	1	N	3	3-8	3-8
16	H Delta Aux OFF	1	N	0	0-7	0-7
17	C Delta Stage 1 ON	1	N	1	1-6	1-6

Config Parameter #	Description	Length (bytes)	Send Unsolicited on change	Default Value	Read values	Write values
26	Backlight Timer	1	N	20	10-30	10-30
33	Max Heat Setpoint	1	N	90	30F - 109F	30F - 109F
34	Min Cool Setpoint	1	N	60	33F - 112F	33F - 112F
38	Schedule Enable	1	N	0	0 = Disabled 1 = Enabled	0 = Disabled 1 = Enabled
40	Setback Mode 3	1	Y	0	0 = No Setback 2 = UnOccupied Mode	0 = No Setback 2 = UnOccupied Mode
41	Un-Occupied HSP 1	1	N	62	30F - 109F	30F - 109F
42	Un-Occupied CSP 1	1	N	80	33F - 112F	33F - 112F
43	Remote Sensor 1 Node Number	1	N	0	0-252 0= Disabled	0-252 0= Disabled
46	Remote Sensor 1 Temperature	1	N	0		n/a
48	Internal Sensor Temp Offset	1	N	0	-7 to 7	-7 to 7
49	R1 Sensor Temp Offset	1	N	0	-7 to 7	-7 to 7
52	Filter Timer (hours)	2	N	0	0-4000+	0-4000
53	Filter Timer Max (hours)	2	N	300	0-4000	0-4000
54	Heat Timer (hours)	2	N	0	0-4000+	0-4000
55	Cool Timer (hours)	2	N	0	0-4000+	0-4000
61	Fan Purge Heat	1	N	0	0-90	0-90
62	Fan Purge Cool	1	N	0	0-90	0-90
170 0xaa	Send Association Autosend with ACKs	1	N	1	0 = Send with no ACK request 1 = Send with ACK request	0 = Send with no ACK request 1 = Send with ACK request
171 0xab	Number of Heat Call Starts	4	N	0	0-0x7FFFFFFF	0-0x7FFFFFFF
172 0xac	Number of Cool Call Starts	4	N	0	0-0x7FFFFFFF	0-0x7FFFFFFF
173 0xad	Reboot Count	4	N	0	0-0x7FFFFFFF	0-0x7FFFFFFF
174 0xae	CPU runtime (sec) (battery mode only)	4	N	0	0-0x7FFFFFFF	n/a
175 0xaf	Autosend Wakeup count	4	N	0	0-0x7FFFFFFF	0-0x7FFFFFFF

Config Parameter #	Description	Length (bytes)	Send Unsolicited on change	Default Value	Read values	Write values
176 0xb0	UI Wakeup count	4	N	0	0-0x7FFFFFFF	0-0x7FFFFFFF
177	Reserved					
178 0xb2	Power Status Bits are set according to power setup.	1			POWER_BATTERY 0x02 PWR_ACINSTALL 0x10 PWR_BATINSTALL 0x20 PWR_FLIRS 0x40	0x01 POWER_24VAC n/a
179 0xB3	Battery Bank Voltage (%)	1	N		0-100	n/a
181 0xB5	Battery (%) Stat Shutdown threshold	1		0	0-50	0-50
182 0xB6	Battery (%) Radio Cutoff threshold	1		10	10-50	10-50
183 0xB7	Battery (%) LOWBATT Indicator threshold	1		20	20-75	20-75
184 0xB8	Battery (%) Threshold value for Midlevel	1		50	50-80	50-80
185 0xB9	Battery Report Timer (days)	1	N	1	0 = Disabled, 1 - 10	0 = Disabled, 1 - 10
186 0xBA	Temperature Delta Autosend Threshold (how many degree change from the last autosend)	1	N	2	1-5 (degrees)	1-5 (degrees)
187 0xBB	Periodic Temperature Send Interval (min)	1	N	0	0 = Disabled, 1 - 120	0 = Disabled, 1 - 120
188	reserved					
189	reserved					
190	reserved					
198	Reserved	4	N		n/a	
221	Rutime-Stage1 Heat (sec)	4	N	0	0-0x7FFFFFFF	0-0x7FFFFFFF
222	Rutime-Stage2 Heat (sec)	4	N	0	0-0x7FFFFFFF	0-0x7FFFFFFF
223	Runtime-Aux Heat (sec)	4	N	0	0-0x7FFFFFFF	0-0x7FFFFFFF
224	Rutime-Stage1 Cool (sec)	4	N	0	0-0x7FFFFFFF	0-0x7FFFFFFF
225	Rutime-Stage2 Cool (sec)	4	N	0	0-0x7FFFFFFF	0-0x7FFFFFFF
226	Runtime-Fan Only (sec)	4	N	0	0-0x7FFFFFFF	0-0x7FFFFFFF

Config Parameter #	Description	Length (bytes)	Send Unsolicited on change	Default Value	Read values	Write values
227	Runtime-Standby (sec)	4	N	0	0-0x7FFFFFFF	0-0x7FFFFFFF
230	reserved					
231	Status Display(0 displays RH on status line, 1 displays setpoints)	1	N	1	0,1	0,1

1 Setting the AWAY setpoints via the CONFIG command class does not maintain the delta-T separation

2

3 Config Parameters can be selectively Enabled to be Sent Unsolicited by setting the appropriate bits in the AutoSend Config Register #23

4 Any change to a Mechanical System setting may cause the current HVAC operation to abort and start an MOT

5 An MOT/MRT change will not take effect until the next MOT or MRT cycle

6 The battery alert enable only applies to the periodic battery report (config reg 185) and not the built in battery threshold alerts (config regs 183, 184)

7 Schedule Enable (#38) must be enabled prior to setting this parameter



INFORMATION TO USER

FCC ID: WIB-TZW500 IC ID: 9374A-W500 FCC Compliance Statement

This device complies with part 15 of the FCC Rules. Operation is subject to the following two conditions: (1) This device may not cause harmful interference, and (2) this device must accept any interference received, including interference that may cause undesired operation.

This equipment has been tested and found to comply with the limits for Class B digital devices, pursuant to Part 15 of the FCC Rules. These limits are designed to provide reasonable protection against harmful interference in a residential installation. This equipment generates uses and can radiate radio frequency energy and, if not installed and used in accordance with the instruction manual, may cause harmful interference to radio communications. However, there is no guarantee that interference will not occur in a particular installation. If this equipment does cause harmful interference to radio or television reception, which can be determined by turning the equipment off and on, the user is encouraged to try to correct the interference by one or more of the following measures:

- Re-orient or relocate the receiving antenna
- Increase the separation between the equipment and receiver
- Connect the equipment to an outlet on a different circuit from the receiver
- Consult the dealer or an experienced radio/TV contractor for help.

Warning: Changes or modifications not expressly approved by Ecolink Intelligent Technology Inc. could void the user's authority to operate the equipment.

(GB) This device complies with Industry Canada license-exempt RSS standard(s). Operation is subject to the following two conditions: (1) this device may not cause interference, and (2) this device must accept any interference, including interference that may cause undesired operation of the device.

(FR) C'et appareil est conforme la norme d'Industrie Canada exempts de licence RSS. Son fonctionnement est soumis aux deux conditions suivantes: (1) c'et appareil ne peut pas provoquer d'interférences, et (2) c'et appareil doit accepter toute interference, y compris les interferences qui peuvent causer un mauvais fonctionnement de la dispositif.

LIMITED WARRANTY

This limited warranty is provided by Ecolink Intelligent Technology ("Ecolink") to you as the original purchaser of the product. Ecolink warrants this product to be free from defects in material and workmanship for a period of one (1) year from the date of original purchase. The determination of whether the product is defective shall be made by Ecolink in its sole discretion with consideration given to the overall performance of the product. If Ecolink determines that any product is defective, Ecolink's sole obligation and your sole and exclusive remedy shall be that Ecolink will replace the product.

This warranty does not apply to damage caused by shipping or handling, or damage caused by accident, abuse, misuse, misapplication, ordinary wear, improper maintenance, failure to follow instructions or as a result of any unauthorized modifications. The foregoing limited warranty is and shall be in lieu of any and all other warranties, whether expressed or implied and of all other obligations or liabilities on the part of Ecolink. Ecolink neither assumes responsibility for, nor authorizes any other person purporting to act on its behalf to modify or to change this warranty, nor to assume for it any other warranty or liability concerning this product. It is recommended that the customer check their equipment on a regular basis for proper operation.

Disclaimer and limitation of liability other than the limited warranty above, Ecolink makes no other warranty or representation, and hereby disclaims any and all implied warranties, including, without limitation, the implied warranties of non-infringement, merchantability and fitness for a particular purpose. You acknowledge that you alone have determined that the product will suitably meet the requirements of the intended use. In no event shall Ecolink or any of its affiliates be liable for any incidental, special, indirect, consequential, or multiple damages, including but not limited to, lost profits, loss or damage to software or data, or damage to equipment arising out of the use of any product, even if Ecolink has been advised of the possibility of such damages. Further, in no event shall the liability of Ecolink or its affiliates exceed the individual price of the product on which liability is asserted.

By the act of use, setup or assembly of the product, you accept all resulting liability. If you as the purchaser or user are not prepared to accept the liability associated with the use of the product, you are advised to return the product immediately in new and unused condition to the place of purchase. Some states do not allow the exclusion or limitation of incidental or consequential damage, so the above limitations may not apply to you.

RETURN POLICY

Please visit us at www.discoverecolink.com/returns to view our return policy. This product covered by one or more claims of patents found at: <http://sipcolc.com/patent-list/>



