



## Mini Dimmer

Mini Dimmer is a MOSFET-switching light device that is compatible with 2 or 3-wire connections, which mean that does not require neutral wire. It supports control of low-voltage halogen lamps with electronic transformers, dimmable compact fluorescent lights, and dimmable LED bulbs. It measures power consumption of the connected device. It supports push-button/momentary switches and toggle switches (default) and can act as a normal switch with non-dimmable lights. Qubino Mini Dimmer allows the easiest and quickest installation. It is designed to act as repeater to improve range and stability of Z-Wave™ network.

### PACKAGE CONTENTS

Mini Dimmer device, Installation Manual, S2 packaging label

### Mini Dimmer supported functions:

Dimming the Lights	✓
ON / OFF Control	✓
Automatic ON / OFF Control	✓
kWh Measurement	✓
W Measurement	✓
2 and 3-wire Installation	✓
Associations	✓
Z-Wave Repeater	✓
Smart start	✓

Check the compatibility with Z-Wave gateways online: <https://qubino.com/products/mini-dimmer/>

### Danger of electrocution!

Installation of this device requires a great degree of skill and may be performed only by a licensed and qualified electrician. Please keep in mind that even when the device is turned off, voltage may still be present in the device's terminals.

### Note!

Do not connect the device to loads exceeding the recommended values. Connect the device exactly as shown in the provided diagrams. Improper wiring may be dangerous and result in equipment damage.

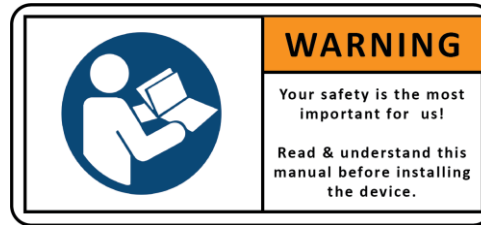





### IMPORTANT DISCLAIMER

Z-Wave wireless communication is not always 100 % reliable. This device should not be used in situations in which life and/or valuables are solely dependent on its functioning. If the device is not recognized by your gateway (hub) or shows up incorrectly, you may need to change the device type manually and make sure your gateway (hub) supports Z-Wave Plus™ multi-level switch devices. Contact us for help before returning the product: <http://qubino.com/support/#email>

### USE IT WITH ALL TYPES OF DIMMABLE BULBS

#### 1. Dim all types of dimmable bulbs

-  **Incandescent** up to 90W/200W
-  **Halogen** up to 90W/200W
-  **LED** up to 65W/150W
-  **LED strip** up to 65W/150W 110-240V
-  **Fluorescent** up to 65W/150W

#### 2. Use it in a 2-wire installation

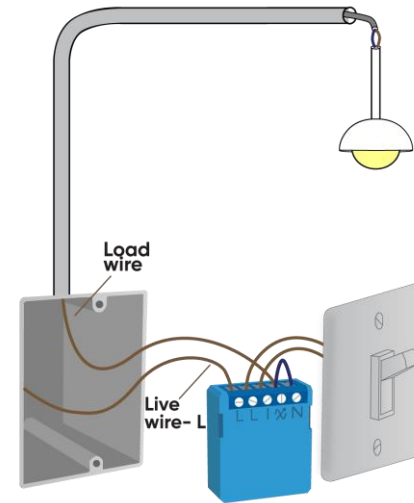

#### 3. Use it in a 3-wire installation

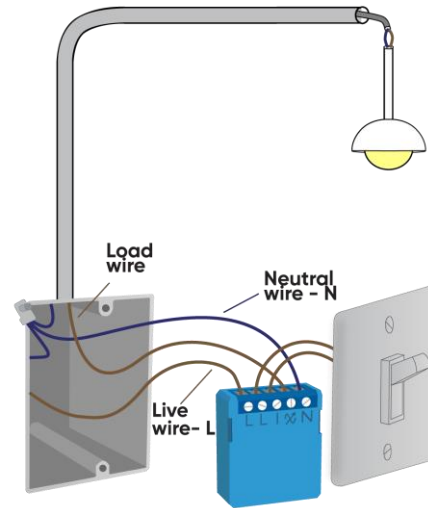

### WARNING

Do not dispose of electrical appliances as unsorted municipal waste, use separate collection facilities. Contact your local government for information regarding the collection systems available. If electrical appliances are disposed of in landfills or dumps, hazardous substances can leak into the groundwater and get into the food chain, damaging your health and well-being. When replacing old appliances with new ones, the retailer is legally obligated to take back your old appliance for disposal free of charge.

### TECHNICAL SPECIFICATIONS

Power supply	110 – 240 Vac ±10 % 50 or 60 Hz (24-30 Vdc)
Rated load current of AC output	0,85 A / 110 -240 Vac
Output circuit power of AC output	200 W* (240 Vac) 90 W (110 Vac)
Power measurement accuracy (2-wire)	±10 %
Power measurement accuracy (3-wire)	±2 %
Operation temperature	-10 ~ +40 °C (14 ~ +104 °F)
Distance	Up to 40 m indoors (131 ft)
Dimensions (wxHxD)(package)	38x33,5x15,5 mm (86x74x43 mm) / 1,50x1,32x0,61 in (3,39x2,91x1,69 in)
Weight (with package)	24 g (50 g) / 0.85 oz (1.76 oz)
Electricity consumption	0,4 W
For installation in boxes	∅ ≥ 60 mm or 2/3M
Switching	MOSFET (Trailing edge)

\* When overload is detected, the *device* automatically switches off. If this happens, check if the load matches *device* specifications and if connections are according to the diagram. To restore the dimmer to regular operation, please power cycle the *device*.

### INSTALLATION STEPS

The installation process, tested and approved by professional electricians, consists of the following simple steps:

- Step 1** – 1. To prevent electrical shock and/or equipment damage, disconnect electrical power at the main fuse or circuit breaker before installation and maintenance.
2. Be aware that even if the circuit breaker is off, some voltage may remain in the wires — before proceeding with the installation, be sure no voltage is present in the wiring.
3. Take extra precautions to avoid accidentally turning on the device during installation.

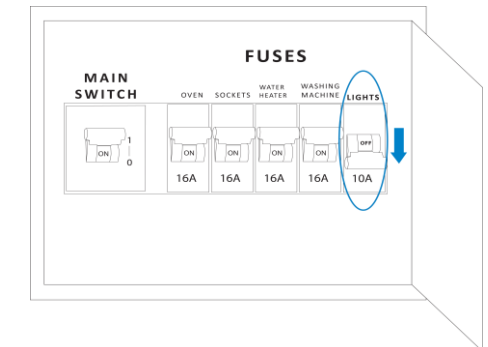

**Step 2** – Connect the device according to the wiring diagram:

**3-wired installation:**

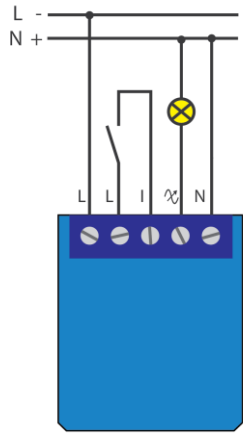

\*24-30 Vdc connection can only be used to add, remove, or reset the device with S button in a 3-wire installation

**2-wired installation:**

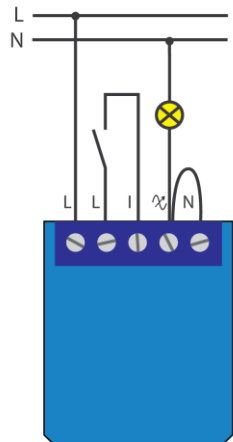

**Notes for the diagram**

- L** Live wire (-Vdc)
- I** Input for push button/switch
- $\infty$  Output for electrical device
- N** Neutral wire (+Vdc)
- S** Service button

**S-Button:**

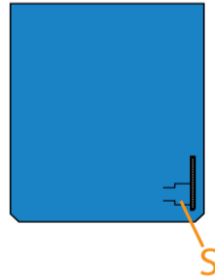

**WARNING!**

The S (Service) button **must NOT** be used when the device is connected to a 110-240 Vac power supply.  
NOTE: if in the 2-wire installation, the connected load starts flickering, we recommend you use a Bypass.

**Step 3** – Place the antenna as far as possible from metal elements as they may cause signal interference.

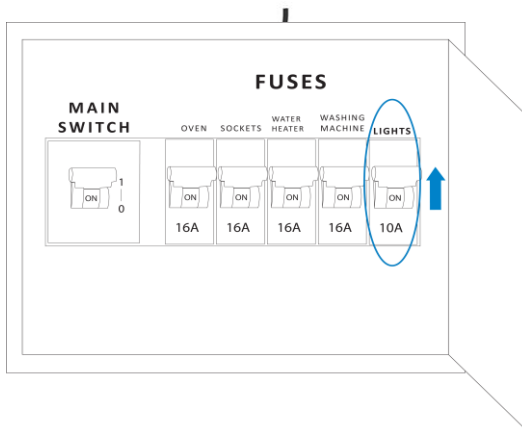

**Step 4** – Turn ON the fuse :

**Step 5** – Add the device to your Z-Wave network:



**Supported loads**

	Conventional incandescent and halogen lights	200 W (240 Vac) 90 W (110 Vac)
	LED bulb, compact fluorescent bulb (CFL), low voltage halogen bulbs with electronic transformer	150 W (240 Vac) / 70 W (110 Vac)
	Low voltage halogen bulbs with conventional Transformer	150 W (240 Vac) / 70 W (110 Vac)

**Z-WAVE INCLUSION**

**SMARTSTART INCLUSION**

SmartStart enabled products can be added into a Z-Wave network by scanning the Z-Wave QR Code present on the product with a controller providing SmartStart inclusion. No further action is required and the SmartStart product will be added automatically within 10 minutes of being switched on in the network vicinity

1. Scan QR code on device label and add S2 DSK to Provisioning List in gateway (hub).
2. Connect the device to the power supply.
3. Make sure the device is within direct range of your Z-Wave gateway (hub).
4. Inclusion will be initiated automatically within few seconds of connection to the power supply and the device will automatically enrol in your network (when the device is excluded and connected to the power supply it automatically enters the LEARN MODE state).

**MANUAL INCLUSION** 1. Enable add/remove mode on your Z-Wave gateway (hub)

2. Connect the device to the power supply
3. Toggle the switch connected to terminal I 3 times within 3 seconds. The device has to get On/Off signal 3 times, meaning 3 times push of the button or with the normal button 3 times On and 3 times Off.

**OR**

If the device is powered by 24 Vdc SELV supply, press and hold the S (Service) button for at least 2 seconds

3. A new dimming device (multilevel switch) will appear on your dashboard
4. Inclusion with the switch connected to terminal I is not limited by time

**Note:** In case of S2 Security inclusion a dialog will appear prompting you to enter the corresponding PIN number (5 underlined digits) that are written on the module label and the label inserted in the packaging (check the example picture).

IMPORTANT: The PIN code must not be lost

**Z-WAVE EXCLUSION/RESET**

**Z-WAVE EXCLUSION**

1. Connect the device to the power supply
2. Make sure the device is within direct range of your Z-Wave gateway (hub) or use a hand-held Z-Wave remote to perform exclusion
3. Enable exclusion mode on your Z-Wave gateway (hub)



4. Toggle the switch connected to terminal I 3 times within 3 seconds. The device has to get On/Off signal 3 times, meaning 3 times push of the button or with the normal button 3 times On and 3 times Off.

**OR**

If the device is powered by 24 Vdc SELV supply, press and hold the S (Service) button for 2 to 6 seconds

5. Exclusion with the switch connected to terminal I is not limited by time
6. The device will be excluded from your network but any custom configuration parameters will not be erased.

**FACTORY RESET**

1. Connect the device to the power supply
2. Within the first minute the device is connected to the power supply, toggle the switch connected to terminal I 5 times within 3 seconds

**OR**

If the device is powered by 24 Vdc SELV supply, press and hold the S (Service) button for at least 6 seconds

By resetting the device, all custom parameters previously set on the device will return to their default values, and the node ID will be deleted. Use this reset procedure only when the main gateway (hub) is missing or otherwise inoperable. If an end device is factory reset, it is reverted to the Z-Wave SmartStart inclusion state

NOTE: See the extended manual for custom settings and parameters available for this device.

**ORDERING CODE AND FREQUENCIES**  
**ZMNHDD3**

Get a real Qubino Z-Wave bible! How-to install, use cases, illustrations and more. Scan the QR code/follow the link below:

<https://qubino.com/products/mini-dimmer/>



**GOAP d.o.o. Nova Gorica**

Ulica Klementa Juga 007, 5250 Solkan, Slovenia

E-mail: [info@qubino.com](mailto:info@qubino.com) ; Tel: +386 5 335 95 00

Web: [www.qubino.com](http://www.qubino.com); Date: 22.12.2021; V 2.2.3

Purpose of control: Operating Control

Type 1 Action, Pollution Degree 2, Impulse Voltage: 2500 V