

## ONE TOUCH MODULE SWITCH INSTALLATION GUIDE

Model no: HTP-150-XX

**NOTE:** XX- denotes the color of glass and metal brim

### INTRODUCTION:

The Hogar Controls® 1-Touch Module operates independently or as part of a Hogar Controls home automation system or with any certified Z-Wave home automation system. It can be installed on standard BS 2 gang boxes and operates either in a bi-stable relay mode or touch pulse mode for scene control with max. load current of 3 amp each. It communicates to the Hogar Controls system using wireless connection.

### BOX CONTENTS:

Touch Module Switch

### TECHNICAL SPECIFICATIONS:

1. The specifications are described below.

Model number	HTP-150
Power requirements	110-240V ~ 50-60Hz
Power consumption standby	<0.5W
<b>Dimensions &amp; Load Ratings</b>	
Dimensions(L X B X H X D) mm	95 X 95 X 32 X 0
Load Rating	700W per each channel, Total max. 700W
<b>Environmental</b>	
Operational temperature	32°F ~ 104°F or 0°C ~ 40°C
Humidity	0-40%
Storage	-4°F ~ 158°F or 20°C ~ 70°C
<b>Wireless Specifications</b>	
Wireless range	100m Outdoor , ~30m Indoor
Radio protocol	Z-Wave
Radio signal power	max 1 mW
Radio Frequency	EU 868.4 MHz IN 865.2 MHz BR/AU 921.4Mhz

### WARNINGS AND CONSIDERATIONS

**!** Turn OFF electrical power before installing or servicing this product. Improper use or installation can cause SERIOUS INJURY, DEATH or LOSS/DAMAGE OF PROPERTY.

**!** WARNING! This device must be protected by a circuit breaker.

**!** WARNING! Connect only in accordance with the diagram presented in the manual. Improper connections maybe dangerous.

**✓** IMPORTANT! This device must be installed by a licensed electrician in accordance with all national and local electrical codes.

**✓** IMPORTANT! If you are unsure about any part of these instructions, consult a qualified electrician.

**✓** IMPORTANT! Using this product in a manner other than outlined in this document voids your warranty. Further, Hogar Controls is NOT liable for any damage incurred with the misuse of this product.

**✓** IMPORTANT! Do NOT use a power screwdriver to install this device. If you do, you may overtighten the screws and strip them. Also, overtightening the screws may interfere with proper switch operation.

**✓** IMPORTANT! This is an electronic device with intricate components. Handle and install with care!

- Hogar Controls products based on Z-Wave technology provide many advantages when compared to similar smart home systems.
- Z-Wave is the leading smart home technology found in millions of products around the world. It is a wireless mesh technology that will not interfere with your Wi-Fi signal and operates on low power. When Z-Wave technology is utilized inside everyday products such as locks and lights, these products become “smart” – giving them the ability to talk to each other and enable you to control the devices and thus your home, from anywhere.
- Z-Wave is a wireless radio frequency technology that lets smart devices talk to and connect with one another. Household products, like lights, door locks and thermostats are made “smart” when Z-Wave connectivity is added inside the product’s design, giving them the capability to communicate and perform the desired functions that you want.
- Z-Wave operates wirelessly and securely. The devices can be easily accessed and controlled remotely on your smartphone, tablet or computer so you can control your smart home from anywhere in the world! The Z-Wave hub receives a command from you via your smartphone, tablet, or computer and routes the command to the destination device.

### INSTALLATION INSTRUCTIONS

2. Ensure that the location and intended use meet the following criteria:

- Do not exceed the load capacity requirements of the Touch Panel Switch. Refer to the load ratings in the specifications above for details.
  - Install in accordance with all national and local electrical codes.
  - The range and performance of the wireless control system is highly dependent on the following: (1) distance between devices; (2) layout of the home; (3) walls separating devices; and (4) electrical equipment located near devices.
3. Turn off the local electrical power by either Switching off the circuit breaker or by removing the fuse from the fuse box. To ensure the wires do NOT have power running to them, use an inductive voltage detector.

**NOTE:** The back box wiring shown in this document is an example. Your wire colors and functions may differ. If you are not sure which wires are the Line In/Hot, Neutral, Load, Traveler, and Earth Ground wires, have a trained electrician perform the installation.

4. Please note that the product operates with 110V-230VAC/50Hz, and it is necessary to have enough "live" wire and the "neutral" wire for an effective installation.

5. The distance between 2 switch boxes should be at least more than 4cm both horizontally and vertically. The distance between switch box to wall surface should be minimum 2cm. Do not install the device in and near regions of high humidity.

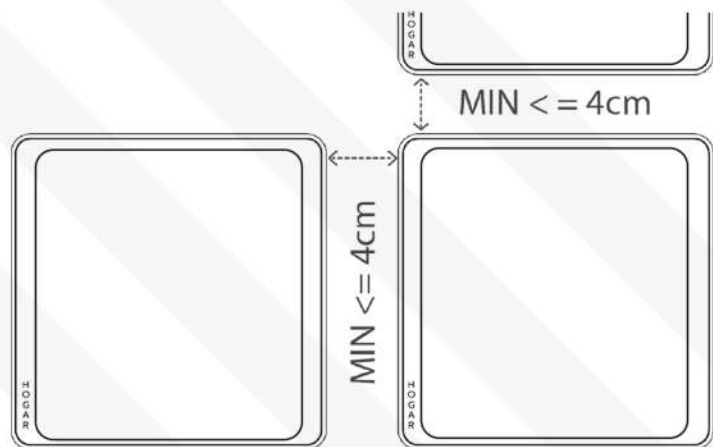

6. The depth from the junction box to the wall surface should be about 2cm

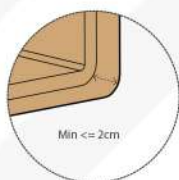
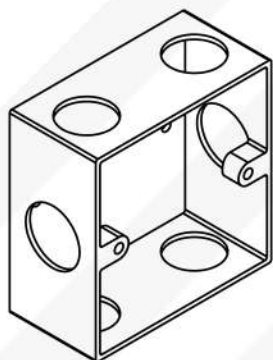

## ▀ DIMENSIONS

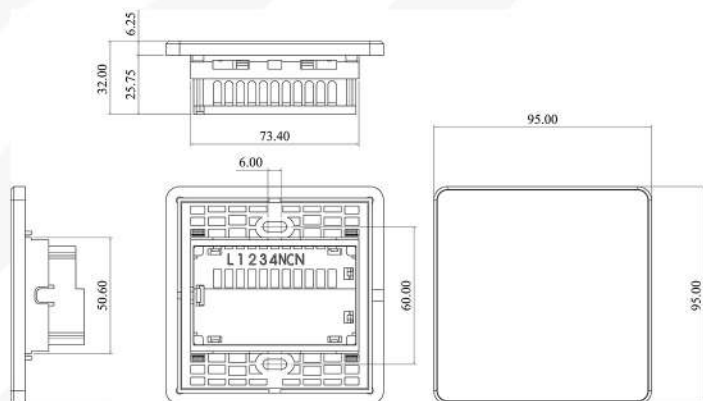

7. Remove the glass panel using a tool as shown below.

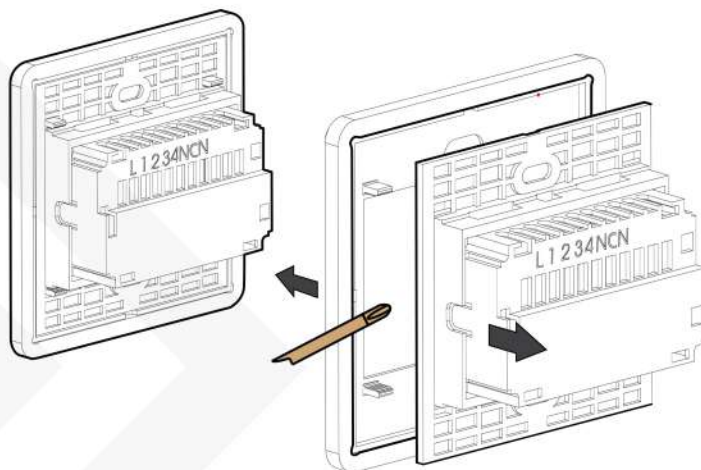
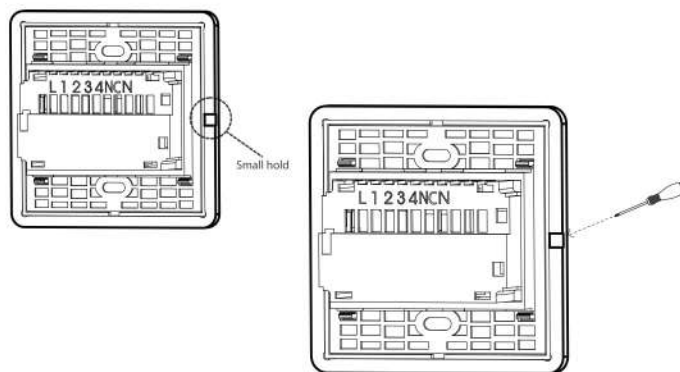

8. The maximum load for each channel is 700W (9Bulk) and 150W (LED, CFL)

9. Hogar Controls 1-Touch Module is designed to operate in a wall switch box of dimensions 161x101mm

10. Prepare each wire. Wire insulation should be stripped back 5/8th of an inch from the wire end.

11. Identify and connect wires according to the physical marks on Hogar Controls Touch Panel Switch, see the appropriate wiring diagram below.

- Live wire to L terminal.
- Neutral wire to N terminal
- L' is Input dry contact for Live \*\*
- L' wire to L terminal need to be looped external for AC load control \*\*
- 1, 2, 3, 4 connected to 1,2,3,4 independent loads

\*\* Not applicable if L' terminal not shown on Terminal marking

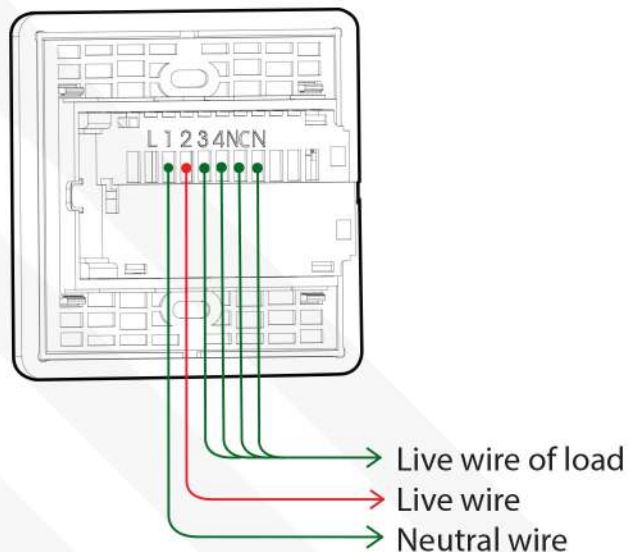

14. Align the 1-Touch Module to the back box and fasten it with screws. Tighten the screws until the back side of the yoke plate is even with the wall surface, but no further. Overtightening can warp the device and cause mechanical malfunction.

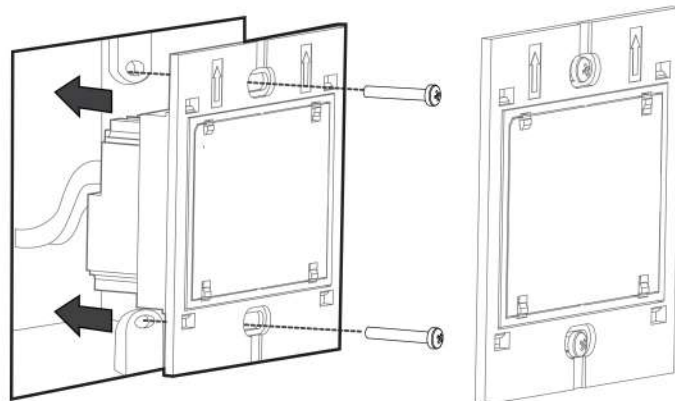

15. Install the Hogar Controls 1-Touch Module Faceplate as shown below. Care should be taken while applying force to avoid any damage to the glass frame faceplate

16. Turn ON power at the circuit breaker

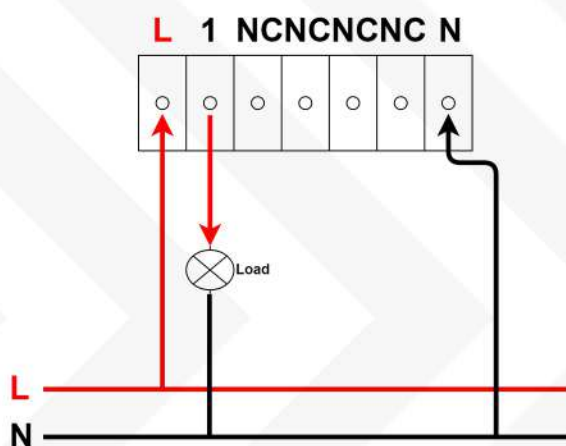

1 Touch Module Connection

12. Identify and connect the back box wires with Touch Module connectors. Make sure the screws are properly tightened to avoid loose connections.

**TIP:** If you are using a Hogar Controls push-on (screw less) faceplate in a multi-gang installation, attach the black faceplate sub-plate to all of the devices that will be installed into the wall box prior to attaching the devices to the wall box. This will help ensure that all the devices are properly aligned and on the same plane after installation.

13. Fit the wires back into the back box. Bend the wires in a zigzag pattern so that they easily fold into the back box.

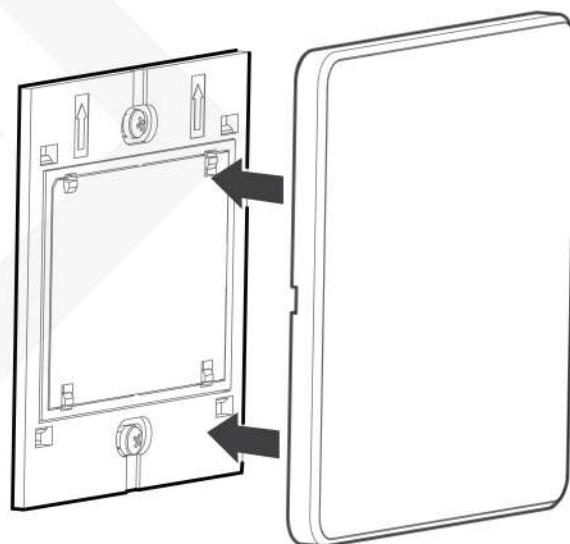

## OPERATION AND CONFIGURATION

On initial power up, all status LEDs on the 1-Touch Module will blink 4 times and turn to a constant blue, indicating device boot up and ready for use.

To operate this Touch Module Switch:

1. For ON/OFF, Touch the button. Red is ON, Blue is OFF

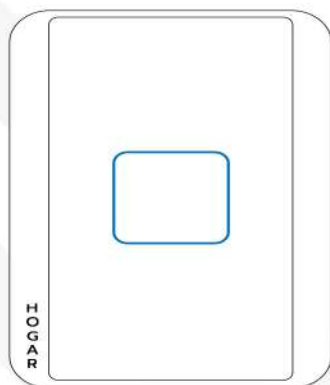

OFF

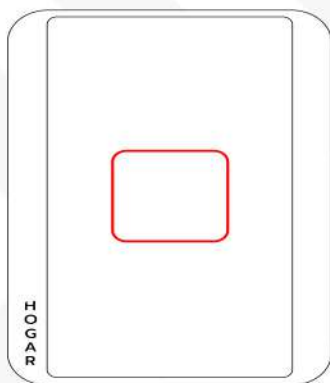

ON

1. Remove the glass panel using a tool.

2. Hold configuration button provided on front PCB using the head of a screwdriver for about 3 seconds until 1 Touch button LED blinks 3 times and all LED turn constant, then release the button.

3. After LED 1 blinks 3 times and all LED illuminate in Pink color, Touch Panel will be in "config mode".

✔ IMPORTANT! Switch will cancel the 'Config Mode' after holding the config button for 8seconds

In the "config mode", the touch button will show either Pink(Toggle) or OFF (Momentary)

5. Touch the buttons which are required to change the mode. LED on the button will turn into Pink or Off.

6. Using a screwdriver press config button again to save the configuration. After that, the switch returns into normal mode

7. Cover the Module and wait for 20 seconds until the control is possible

## ▲ OPERATING MODES OF THE SWITCH

All switches have two operating modes that can be changed: Toggle and Momentary.

- Toggle: A switch with two physical states. An action by the user (e.g. pressing a button) moves the switch from state 1 to state 2. The switch then remains in that state until another action from the user returns it to state 1.

- Momentary: A switch with two physical states. An action by the user (e.g. pressing a button) moves the switch from state 1 to state 2. When the user ends his action (e.g. releases the button) the switch returns to state 1. This state is useful in controlling scenes, Insert Fan Dimmer speed control and motorized curtains

✔ IMPORTANT! Initial operating mode of the switch is "Toggle" mode.

Follow the steps below to switch between the two operating modes. All switch types do the same for selected mode.

## ▲ INCLUDING TOUCH PANEL TO Z-WAVE NETWORK

Step 1: Keep the device in Z-Wave range and set the Home Controller in include/exclude mode (refer to Controller manual)

Step 2: Touch and Hold any touch button for 5s until all LED blink in blue color and the controller shows the 'device found' message.

Step 3: Wait until device update finishes and shows all the parameters of the 1-Touch Module.

Step 4: Rename the touch buttons, assign to desired room and save it (refer to controller manual)

## ▲ EXCLUDING A SWITCH FROM THE NETWORK

Step 1: Keep the device in Z-Wave range and set the Home Controller in include/exclude mode to remove (refer to Controller manual)

Step 2: Touch and Hold any touch button for 5s until all LED blink in blue color and the controller shows the 'device found' message.

Step3: Wait until the touch panel configuration is removed from the Controller and save.

## ▲ RESET A SWITCH TO THE FACTORY STATE

Hold any touch button for about 15 seconds until all LED blink in RED color indicating a factory reset. Please use this procedure only when the network primary controller is missing or otherwise inoperable.

## ▲ ADVANCED Z-WAVE CONFIGURATION

Warning: Changing the parameters might affect the Z-Wave network performance and result in undesired operation.

Hogar's Touch Modules in 2nd, 3rd group allows to control 5 regular or multichannel devices per an association group, with the exception of "Lifeline" that is reserved solely for the controller and hence only 1 node can be assigned.

It is not recommended to associate more than 10 devices in general, as the response time to control commands depends on the number of associated devices. In extreme cases, system response may be delayed.

## ▲ WARRANTY

The manufacturer is only responsible for equipment malfunction resulting from physical defects of the device for up to 24 months from the date of purchasing.

The warranty policy will not be applied for cases such as below:

- Damages resulting from external causes, e.g.: flood, storm, fire, lightning, natural disasters, earthquakes, high or low temperature and weather condition.
- Damages resulting from not following the instructions of operating manual.
- Damages caused by faulty electrical installation by the customer, including the use of incorrect fuses.
- Mechanical damages (cracks, fractures, cuts, abrasions, physical deformations caused by impact, falling or dropping the device or other object, improper use or by not observing the operating manual)

## ▲ TROUBLESHOOTING

If the light does not turn on:

- Ensure at least one LED on the face of the Touch Module Switch is lit.
- Ensure the light bulb is not burned out and is screwed in tightly.
- Ensure that the circuit breaker is not turned OFF or tripped.
- Check for proper wiring (see “Sample Wiring Configurations”).
- For help on the installation or operation of this product, email or call the Hogar Controls Technical Support Center. Please provide your exact model number. Contact us or see the web site [www.hogarcontrols.com](http://www.hogarcontrols.com).

## ▲ CARE AND CLEANING

- Do NOT paint the Touch Module Switch or its wall plate.
- Do NOT use any chemical cleaners to clean the Touch Module Switch.
- Clean surface of the Touch Module Switch with a soft damp cloth as needed.

## ▲ REGULATORY/SAFETY INFORMATION

To review Regulatory information for your particular Hogar Controls products, see the information located on the Hogar Controls website at: <http://www.hogarcontrols.com/>.

## ▲ ABOUT THIS DOCUMENT

Copyright ©2016 Hogar Controls. All rights reserved. Hogar Controls, the Hogar Controls logo, the Hogar Controls emblem logo and the Hogar Controls certified logo are registered trademarks or trademarks of Hogar Controls Corporation in the United Kingdom and other countries. All other names and brands may be claimed as the property of their respective owners. Specifications are subject to change without notice.

## Command Class

The Command Class that the device supports  
Command Class of root device

No	CommandClass	Non -secure added	Securely added	
			Non-secure CC	Secure CC
1	COMMAND_CLASS_ZWAVEPLUS_INFO_V2	Support	Support	
2	COMMAND_CLASS_VERSION_V3	Support		Support
3	COMMAND_CLASS_MANUFACTURER_SPECIFIC_V2	Support		Support
4	COMMAND_CLASS_DEVICE_RESET_LOCALLY	Support		Support
5	COMMAND_CLASS_ASSOCIATION_V2	Support		Support
6	COMMAND_CLASS_ASSOCIATION_GRP_INFO	Support		Support
7	COMMAND_CLASS_MULTI_CHANNEL_V4	Support		Support
8	COMMAND_CLASS_MULTI_CHANNEL_ASSOCIATION_V3	Support		Support
9	COMMAND_CLASS_BASIC	Support		Support
10	COMMAND_CLASS_SWITCH_BINARY	Support		Support
11	COMMAND_CLASS_FIRMWARE_UPDATE_MD_V4	Support		Support
12	COMMAND_CLASS_TRANSPORT_SERVICE_V2	Support	Support	
13	COMMAND_CLASS_SECURITY_2	Support	Support	
14	COMMAND_CLASS_SUPERVISION	Support	Support	
15	COMMAND_CLASS_POWERLEVEL	Support		Support

### Basic command class mapping

- Basic Set = 255 maps to Binary Switch Set = 255
- Basic Set = 0 maps to Binary Switch Set = 0
- Basic Get/Report maps to Binary Switch Get/Report

### AGI Configuration

Table below show AGI information.

Device report status through root device lifeline group #1.

Device support control other device through root device association group #2~#3, and each group support 5 destination nodes maximum.

Root	Profile	Commands	Group Name
Group 1	General: Lifeline	Device Reset Locally Switch Binary Report	"Lifeline"
Group 2	Control: Key01	Basic Set	"HGT-01"
Group 3	Control: Key01	Switch Binary Set	"HGT-01"

Hogar's Touch Switch in 2nd, 3rdgroup allows to control 5 regular or multichannel devices per an association group.

It is not recommended to associate more than 10 devices in general, as the response time to control commands depends on the number of associated devices. In extreme cases, system response may be delayed.



HOGAR

